

EN Instruction manual



Fuego ^{SCS} *basic*

Safety Enhanced
Laboratory Gas
Burner





- 1 - Function knob
- 2 - Dual knob: - Gas adjustment
- Air adjustment
- 3 - LED Standard
- 4 - LED StartStop
- 5 - LED Button
- 6 - LED Burner head HOT / BHC
- 7 - Burner head
- 7a - Flame orifice

- 8 - Connector for foot pedal
- 9 - Power connector for 9 V DC
- 10 - Gas inlet R 1/4" L
(left hand thread)
- 11 - Holding device for
inoculation loop holder

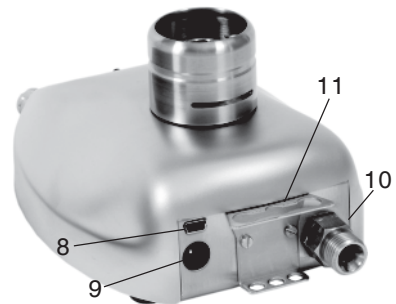

- 12 - Burner head screw
- 13 - Monitor electrode
- 14 - Ignition electrode



- 15 - Active nozzle
- 16 - Nozzle holder for
alternative gas
- 17 - Cover of the burner
shaft
- 18 - Retaining screw for
cover of the burner shaft
- 18a- Position screw for the
cover
- 19 - Guide slots for
tilt adjustment

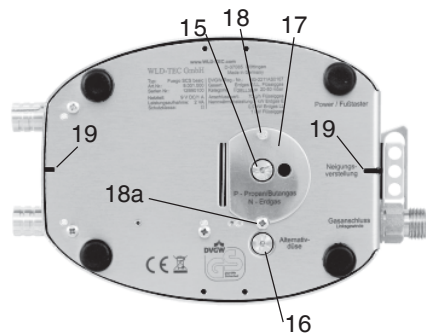

Read these instructions carefully to familiarize yourself with the product. Please retain these operating instruction for future reference.

Use

**Safety laboratory gas burners for heating and flame sterilizing.
Ideal for use in cleanroom workbenches and laboratory.**



All users who have been assigned to use this device must have read and understood these operating instructions or have been instructed by an expert user so that this device can be used safely without causing danger.

**WARNING: DO NOT LEAVE THE ACTIVATED LABORATORY
GAS BURNER UNATTENDED!**

Safety Precautions

- **On unpacking the unit, check for possible transportation damages. Do not operate the unit if damages are visible.**
- **The device can be dangerous if operated or used in an incorrect manner by untrained staff.**
- **An incorrect gas connection may create a hazard. Observe the installation instructions in the manual.**
- **Pay attention to your relevant rules for using liquid gas.**
- **Only use DVGW safety tubings with thread or tubing connectors. Check the condition of the tube/hose frequently. Depending upon type of tube/hose, hose clamps are required.**
- **After use or for any longer period of time without attendance, turn the main gas supply off and turn off the gas burner at the function knob (1).**
- **All gas connections must be adequately tightened (left-hand thread). Ensure gas proofness with suitable test equipment. DO NOT seal the swivel nut on the safety laboratory gas burner (10) with Teflon tape, etc.**
- **BEFORE using the device carefully check the gas feed tube for leaks. Check this even if the device has been installed by your distributor. To do this, carry out all the procedures mentioned in these operating instructions (see paragraph 1).**
- **Do not operate the unit near flammable liquids or hazardous materials.**
- **Unattended operation of the unit is not permissible.**
- **Do not use the device if there is a smell of gas or if there is a leak.**
- **In the event that gas can be smelled: immediately turn off the gas supply to the device. Extinguish any open flames. Pull out the mains plug. Check all gas connections for gas proofness. If the smell of gas persists, the appropriate authorities must be notified (janitor, gas utility company, Fire Brigade).
LEAKING GAS CAN CAUSE A FIRE OR AN EXPLOSION. THIS MAY RESULT IN SEVERE INJURIES, FATAL ACCIDENTS AND DAMAGE TO PROPERTY.**

- **NEVER** use a open flame to look for leaks.
- **Do not smoke** if you are searching for leaks.
- **NEVER** try to loosen or unfasten gas connections while the gas supply is turned on and the device is in operation.
- **Do not store spare or unconnected gas cartridges / gas bottles in the vicinity of this device.**
- **Even in an apparently empty gas cartridge/gas bottle, some gas may still remain. Gas cartridges/gas bottles should be transported and stored accordingly. Empty gas cartridges should be properly disposed.**
- **Always work in a well-ventilated area.**
- **When working with this device, always wear protective glasses.**
- **Do not allow anything to fall into the flame orifice (7a).**
- **Keep hands or other parts of the body away from the burner orifice (7a).**
- **Note that the burner orifice (7) remains hot after the flame has been extinguished. Do not touch. Can cause burns.**
- **Allow sufficient time for flame orifice (7a) to cool down prior to cleaning, disinfecting, servicing or transport. Ensure that the unit and the gas supply are turned off.**
- **Because of the connectors at the back of the unit the backside should not be sterilized with a flame.**
- **Allow sufficient time for burner head (7) to cool down prior to disassembling.**
- **Operate the unit with assembled burner head (7) only.**
- **After cleaning the burner head (7) allow sufficient time to dry before assembling again.**
- **Before mounting a nozzle check the O-Ring (20). Replace the O-Ring if damaged or worn (see paragraph 1).**



The range: Fuego SCS basic

Art.-No. 8.201.000

with foot pedal (26)

3 standard-programs for button (function knob) and foot pedal

SCS (Safety Control System)

BHC (Burner Head Control)

Removable and decomposable burner head

Tilt mechanism, right / left (23)

Holding device for 3 inoculation loop holders (11)

Nozzles for natural gas, propane/butane gas

Turbo flame

Wrench 17 mm (21) for gas connection

Screwdriver (22) for burner head and

cover of the burner shaft

Tubing connector with swivel nut (24)

Power connection, global (25)

Instruction manual and 2-year warranty



1. Setup Procedure:

The unit is shipped with the nozzle for natural gas N (08) installed.

The nozzle must be changed if other gas is to be used.

Replacement procedure: Remove the Nozzle P (06) from the nozzle holder (16) with a coin or the edge of the wrench (21) by turning it counterclockwise. Remove the active Nozzle N (08) for natural gas (15) in the same way and exchange the nozzles.

ATTENTION: Before mounting a nozzle check the O-Ring (20).

Replace the sealing if damaged or worn (Art.-No. 8.000.010).

Now you are ready to connect the gas supply to the gas inlet (10).

The correct pressure for natural gas is within the range of 18 - 25 mbar, for propane/butane gas 28 - 57 mbar.

Only use DVGW or other gas approved safety tubings with thread or tubing connectors (24). Check the condition of the tube/hose frequently. Depending upon type of tube/hose, hose clamps are required.

All gas connections must be adequately tightened with the wrench (21) (SW 17mm, included). Ensure gas proofness with a suitable test fluid / equipment. Do not seal up the included tubing connector (24) and swivel nut with Teflon tape etc.

A DVGW-proven or other gas approved pressure regulator (50mbar) must be used for liquid gas.

Pay attention to your relevant rules for using liquid gas.

1.1 Foot pedal connection:

Insert the connection cable of the foot pedal into the socket (8) at the back of the unit.

Note: The LEDs Standard (3) and Start-Stop (4) will flash alternately until a foot pedal has been connected to the foot pedal socket (8).

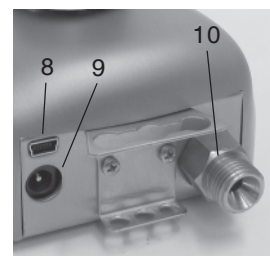
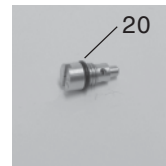
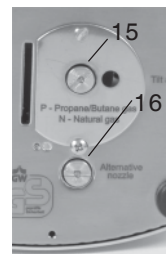

1.2 Electrical connection:

Plug the power cable into the socket (9) on the back of the unit or into the socket on the foot pedal. The mains power supply unit included is designed for a voltage from 100 - 240 V, 50/60 Hz. The mains power supply unit may only be connected if these values comply with the intended electricity supply. Before using it, push the corresponding socket adapter onto the mains power supply plug (see „Instruction manual Power adapter”, page 14).

2. Operation: Flame regulation

The flame can be varied in size and intensity by turning the gas / air knob (2). Regulating the size of the flame is done by turning the gas / air adjustment. Regulating the air intake for the flame intensity is carried out by **pulling outwards and at the same time rotating** the gas / air adjustment.



When using for the first time or changing the gas type, turn the gas adjustment knob two revolutions to the left. Then pull the gas / air adjustment outwards and simultaneously turn it one revolution to the left to open the air intake.

2.1 Operation: On-Off switch, operating mode

Switch the unit on by a short push on the function knob (1). It can be turned off by a long push (2 seconds +) on the function knob. By turning the function knob (1) the foot pedal operating modes “Standard” and “StartStop” or the operating mode “Button” can be chosen. The corresponding LED lights up.

2.2 Operation: Application programs

- **BUTTON StartStop:** The flame is ignited by operation of the function knob (1). The flame is extinguished after renewed actuation of the function knob (1). Additionally the flame is automatically extinguished when the burning timer has expired after 60 min.

- PEDAL Standard:

The flame is ignited by operation of the foot pedal. The foot pedal remains depressed for the duration of use. The flame is extinguished upon release of the pedal.

- PEDAL Start-Stop:

The flame is ignited by operation of the foot pedal. The flame is extinguished after renewed actuation of the foot pedal. Additionally the flame is automatically extinguished when the burning timer has expired after 60 min. Alternatively the flame can be extinguished by a short push on the function knob.

Note: The LEDs Standard (3) and Start-Stop (4) will flash alternately until a foot pedal has been connected to the foot pedal socket (8). Without foot pedal, operation is possible with application program BUTTON StartStop only.

2.3 Operation: Switch-off

The unit can be turned off by pushing the function knob (1) for more than 2 seconds.

3. Safety symbols and safety functions:

- **Residual heat display:** LED “Burner head HOT / BHC“  indicates a hot burner head.

Attention: If the LED “burner head HOT / BHC“ lights up DO NOT TOUCH the burner head. Can cause burns! Even after switching-off the unit the residual heat LED remains on till the burner head is cooled down.

Notice: Disconnecting the power supply or removing the power cord will clear the residual heat display even if the burner head is still hot.

- **BHC:** If the burner head is clogged the amber LED “Burner head HOT / BHC” will flash. Additionally, if “burner head HOT / BHC” is flashing, the maximum burning time in the operating mode “Button” and Pedal “StartStop” is limited to 30 seconds (**see paragraph 2.2**). If burning times longer than 30 seconds are required in case of a clogged burner head, the operating mode “Standard” can be used without time limit. If “burner head HOT / BHC” is flashing it is requested to clean the burner head immediately (**see paragraph 5.1**).
- **Automatic unit switch off:** The unit switches itself off automatically after 4 hours if the flame has not been lit in this period. All indicated malfunctions are automatically switched off after 4 hours, too. For further operation, switch the unit on again.

4. Error displays:

- **Ignition failure: Green LED “Button“, “Standard“ or “StartStop“ blinks 2x**
This signal appears and indicates a malfunction if the flame fails to ignite after 7 seconds. In case of ignition failure check the burner head (7) for possible clogging, check the correct input pressure of the gas supply and verify that the correct nozzle is installed. In case of this malfunction the gas supply will be shut off automatically.
Nozzle **N (08)**: natural gas, 18-25 mbar Nozzle **P (06)**: propane-/ butane gas, 47-57 mbar
- **Flame failure: Green LED “Button“, “Standard“ or “StartStop“ blinks 3x**
This signal indicates a malfunction if the flame is extinguished by external factors and fails to reignite within 5 sec. In case of flame failure check the burner head (7) for possible clogging and verify the correct input pressure of the gas supply. In case of this malfunction the gas supply will be shut off automatically.
- **Overtemperature: Green LED “Button“, “Standard“ or “StartStop“ blinks 4x**
This signal indicates a malfunction if the interior temperature has exceeded 70 °C. At a normal room temperature with normal air circulation the unit is suited for continuous operation. In case of overtemperature increase the air ventilation or change the operation site. In case of this malfunction the gas supply will be shut off automatically.
- **Burner head assembly monitor: Green LED “Button“, “Standard“ or “StartStop“ blinks 5x**
This message indicates that the burner head is removed. Further operation is possible after the burner head is reinstalled.
- **BHC: Amber LED “burner head HOT / BHC“ flashes**
This signal indicates that the time limit (30 seconds) is turned on in operating mode “StartStop“ and “Button“ due to a clogged burner head. For cleaning the burner head **see paragraph 5.1**.

Notice: All error displays can be reset by a long push (2 seconds+) on the function knob (1). (In case of overtemperature the unit needs to be cooled down and in case of burner head assembly monitor the burner head needs to be reinstalled prior a reset is possible.)

5. Cleaning and sterilizing:

Allow sufficient time for burner orifice (7, 7a) to cool down before disassembling or cleaning the burner head. Check the unit is disconnected and that the gas supply is turned off at the mains. The burner can be cleaned with customary commercial disinfectants. Additionally, it is possible to remove the burner head and to clean it separately. The stainless steel and glass construction allow 100% UV-radiation sterilization and short time surface flame sterilization.

Attention: Because of the connectors at the back of the unit the backside should not be sterilized with a flame.

5.1 Burner head disassembly and cleaning:

Allow sufficient time for burner orifice (7,7a) to cool down before disassembling or cleaning the burner head. Check the unit is turned off, that the gas supply is turned off at the mains. Clean the burner head with customary commercial disinfectants, sterilize it in an autoclave or wash it in a dishwasher. To remove the burner head proceed as follows:

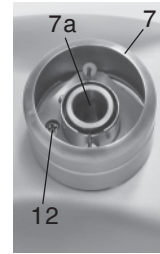
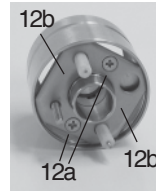

Unscrew the burner head screw (12) completely with the included screwdriver. Turn approx. 8 revolutions to the left.

Now remove the burner head from the device by pulling it upwards. Reinstallation is performed in the reverse sequence. The dismantled burner head can be even dismantled into the individual components for in-depth cleaning: Unscrew both screws (12a) and take off the base plate (12b) of the burner head which was fixed by the two screws (12a). After the base plate is removed both electrodes can be pulled out for separate cleaning. Reinstallation is performed in the reverse sequence.

Notice: When dismantling the burner head completely the sealing ring placed around the burner head screw (12) could dropout. Ensure that the sealing ring is placed around the burner head screw (12) when reassembling.

5.2 Burner shaft cleaning:

Unscrew the screw (18) completely with the included screwdriver. Take off the cover (17) of the burner shaft. Now the burner shaft can be cleaned or solid substances which have fallen into the unit can be removed.

Reinstallation is performed in the reverse sequence. Take care that the notch of the cover fits to the screw (18a).

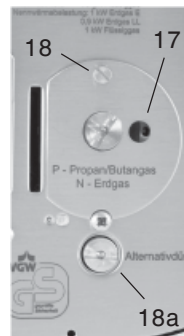

6. Turbo flame:

If the cover of the burner shaft (17) is removed the flame is extremely firm and consistent. To take off the cover of the burner shaft unscrew the screw (18) completely with the included screwdriver. With an open burner shaft the intensity of the flame cannot be adjusted by the air knob any longer. During the use of the turbo flame most of the needed air is taken inside through the open burner shaft. Remounting the cover of burner shaft. (see paragraph 5.2)

7. Tilt adjustment:

Insert the tilt adjustment (23) into the slots (19) at the bottom of the unit. The tilt-adjustment can be used to the left or right side to protect the burning chamber from contamination when working with liquids.

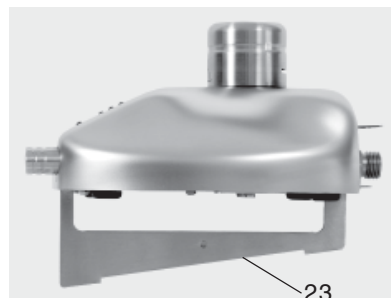

8. Warranty:

All Fuegos are covered under our two-year manufacturer warranty against any manufacture defects in material and workmanship. The WLD-TEC warranty guarantees all Fuegos under normal usage conditions and does not cover any damages as a direct result of user misuse or/and abuse. The warranty is void upon any unauthorized servicing, disassembly or modifications.

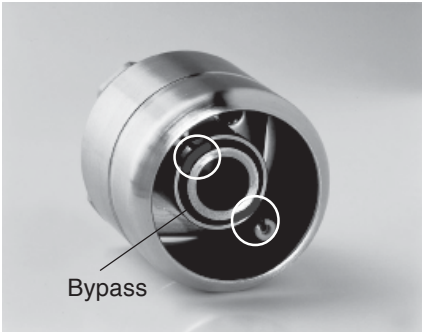
Troubleshooting guide	
The green LED “Standard“ or “StartStop“ does not light up Check for correct connection and specification of the power adapter. Ensure that the original power adapter is used. Specifications: 9 V / DC, 1A Polarity: + —  —	
The foot pedal does not work Check for correct connection of the foot pedal. Ensure that the foot pedal socket and plug is not twisted or broken.	
No Flame In case of ignition or flame failure check if the burner head is clogged. Verify the input pressure of the used gas. Ensure that the correct nozzle is installed in the unit. Nozzle N (08) : natural gas, input pressure: 18-25 mbar Nozzle P (06) : propane / butane gas, input pressure: 47-57 mbar	
	<p>LED “Burner head HOT / BHC“ flashes / Inspection of the burner head (clogging) Take care that there are no liquids or other substances at the Bypass (area between the inner and the outer ring) Especially remove substances in the marked areas at the electrodes. If there are contaminants in this area, the flame cannot encircle the electrodes correctly.</p> <p>Clean this areas with a brush. The burner head can be cleaned with customary commercial disinfectants, or it can be sterilized in an autoclave or washed in a dishwasher.</p>
In operating mode “Button“ or Pedal “StartStop“ flame burns 30 seconds, only BHC time limit is active, LED “burner head HOT / BHC“ is flashing. The burner head is clogged and must be cleaned (see paragraph 3 and 5.1).	
Flame too small / large / soft Check the position of the air and gas adjustment. Check if the correct nozzle is installed. Nozzle N (08) : natural gas, 18-25 mbar Nozzle P (06) : propane / butane gas, 47-57 mbar Check if the drilling of the active nozzle is blocked. Unscrew the active nozzle. (see paragraph 1) If the drillig is blocked clean with a brush or compressed air.	
No ignition spark/LED “Burner head HOT / BHC“ flashes but the burner head is clean Check if the ceramic electrodes are in good condition. In some cases the electrodes may break. To check move the ends of the electrodes. If they are not moving they should be okay. If they are moving more than 0.5 mm the electrodes are broken. The electrodes can be dismantled and changed by the user. (see paragraph 5.1)	

<p>The burner shuts-off due to overtemperature frequently In case of overtemperature increase the air ventilation or change the operation site.</p>
<p>Green LED “Button“, “Standard“ or „StartStop“ blinks 2x Ignition failure (see paragraph 4)</p>
<p>Green LED “Button“, “Standard“ or „StartStop“ blinks 3x Flame failure (see paragraph 4)</p>
<p>Green LED “Button“, “Standard“ or „StartStop“ blinks 4x Overtemperature (see paragraph 4)</p>
<p>Green LED “Button“, “Standard“ or „StartStop“ blinks 5x This message indicates that the burner head is removed or not mounted correctly. Reinstall burner head and reset the unit by a long push on the function knob (1) (see paragraph 4).</p>
<p>Amber LED “Burner head HOT / BHC“ is on permanently Residual heat display is active. Attention: DO NOT TOUCH the burner head (see paragraph 3).</p>
<p>Service address:</p> <p>WLD-TEC GmbH Production & Service Halle-Kasseler-Str.49 37318 Arenshausen Germany</p> <p>Telefon: +49 36081 68940 Telefax: +49 36081 68942 Email: sales@wld-tec.com Internet: www.wld-tec.com</p>



EG-KONFORMITÄTSERKLÄRUNG

Declaration of Conformity

zu den Richtlinien 2004/108/EG und 2006/95/EG

Following the Directives 2004/108/EC and 2006/95/EC

Der elektronische Laborgasbrenner der Serie:

Electronic Laboratory gas burner

Fuego SCS basic Typ / type 8.201.000

erfüllt die in den nachfolgenden Prüfgrundlagen aufgeführten Anforderungen in Verbindung mit den in Anhang A2 aufgeführten Netzgeräten.

This declaration relates is in conformity with the relevant provisions of the following standards together with the normative document A2 mains connection.

1. **Elektromagnetische Verträglichkeit**
Electromagnetic Compatibility Directive
 - 1.1 **EN 61326-1: 2006** **Elektrische Betriebsmittel für Leittechnik und Laboreinsatz, EMV-Anforderungen**
EN 61326-1: 2006 Electrical equipment for measurement, control and laboratory use, EMC requirements
Störaussendung: **Elektrische Betriebsmittel der Klasse B, Gruppe 1**
Generic Emission Standard: Electrical Equipment, class B, Group 1
Störfestigkeit: **Industrielle Bereiche**
Generic Immunity Standard: Industrial areas
2. **Sicherheit elektrischer Betriebsmittel**
Security of electrical resources
EN 61010-1:2001 Sicherheitsanforderungen an elektrische Meß-, Steuer-, Regel- und Laborgeräte. Teil1: Allgemeine Anforderungen
EN 61010-1: 2001 Safety requirements for electrical equipment for measurement, control, and laboratory use. Part 1: General requirements

Göttingen den 01.07.2009

B. Wartewig
Geschäftsführer
Manufacturer

Technical data:

Technology Microprocessor

Programs

Foot pedal: Standard (flame during pressed foot pedal)
Start-Stop with timer, 60 min
Button: Start-Stop with timer, 60 min

Safety features

Safety Control System (SCS): ignition and flame control, temperature monitor
with gas safety cut off burner head clogging and
assembly monitor (BHC)
automatic unit switch off, 4h
residual heat display



Gas supply and consumption

Gas supply: 1/4" left + filter
Gas types: natural gas E/LL, 18 - 25 mbar
liquid gas II2ELL3B/P, 20 - 50 mbar
70 g/h liquid gas
Connected load:
Continuous cartridge operation: CV 360 - 40 min, Express 444 - 50 min,
CG 1750 - 150 min, C 206 - 170 min,
CP 250 - 210 min, CV 470 - 370min

Temperatures

Flame temperature: 1350 °C on liquid gas
1300 °C on natural gas (E)
Temperature threshold level: 1 kW liquid gas, 1 kW natural gas

Electrical

Power consumption: 2 VA
Power connection: 100 - 240 V / 50/60 Hz / max. 0.3 A
9 V DC / 1 A

Mechanical

Casing and operating controls: stainless steel / glass, UV and solvent resistant
Burner head: removable and decomposable, stainless steel
Cover of the burner shaft: Ø 23 mm, with drains
Measurements (B x H x T): 103 x 49 x 130 mm
Weight: 700 g

Licences

DIN-DVGW Reg.-No.: NG-2211AS0167
CE: EN 61326-1, EN 61010-1
EEC guidelines: 2004/108/EC and 2006/95/EC

Instruction manual Power Adapter

The range

AC plugs

- 1 - EU
- 2 - US
- 3 - AUS
- 4 - UK

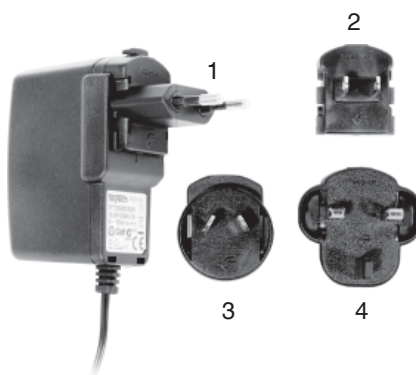

Removal

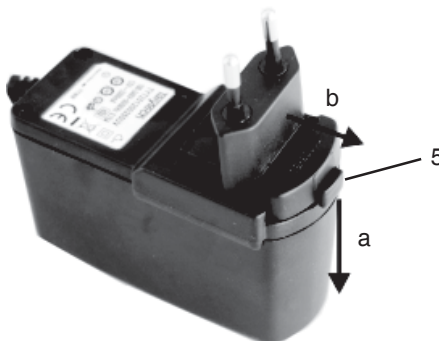

1. Push the release lever **(5)** down in direction **(a)**
2. Push the adapter in direction **(b)** and remove.

Assembling

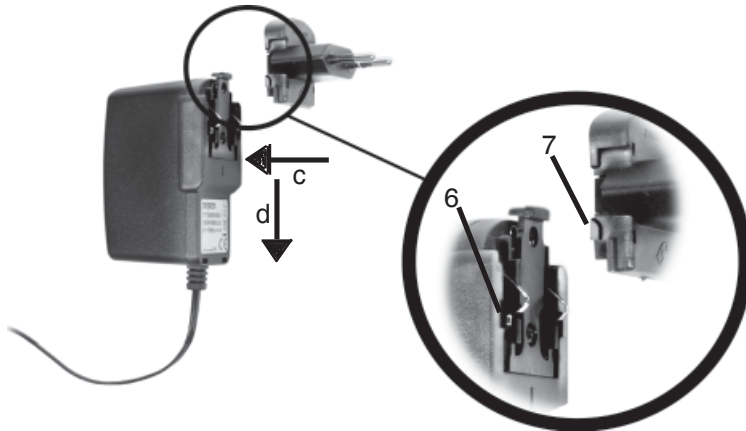

1. Select a socket adapter (1-4) suitable for the area of application.
2. Fit the counterpiece on the adapter (7) into the groove (6) and press in direction (c).
3. Push the adapter in direction (d) until you hear its slot into place.

Notes



WLD - TEC GmbH

Sales department:

Spandauer Weg 1

D - 37085 Göttingen

Phone: +49 (0)551/793789

Fax: +49 (0)551/793707

Production and Service:

Halle-Kasseler Straße 49

D - 37318 Arenshausen

Phone: +49 (0)36081/68940

Fax: +49 (0)36081/68942

Internet: <http://www.wld-tec.com>

Email: sales@wld-tec.com

01/12