



Shenchen Pump

Peristaltic Pump

Pump Equipment Line



Exported to 95 countries



Do Not Copy!!

레보딕스(주) 카다로그들은 저작권법에 의거하여 보호받고 있습니다.
승인없이 이미지 무단 도용시 저작권법에 의해 법적 조치를 받을 수 있습니다.





COMPANY



IN 2014-2019

2019

Leading Brand", which can replace imported brand and conform to European standards, and has been exported to 95 countries around the world.



IN 2010-2013

2010

Shenchen upgrade all the products and successfully entered the international market.



IN 2009

2009

Shenchen products continuously fill gaps in the market.

Baoding Shenchen Precision Pump Co., Ltd

Baoding Shenchen Precision Pump Co., Ltd. is a high-tech enterprise, specialized in R&D, manufacturer and sales of peristaltic pump, syringe pump, gear pump and other precision fluid transferring equipment. Also can do OEM product according with customers' different requirements.

Shenchen team is a high-qualified, young and innovative team, have research engineer, application engineer and professional sales and service team. With rich technical force, excellent technological process and outstanding product quality, Shenchen get well corporate reputation from global customers.

Shenchen products are widely used in research laboratory, bio-pharmaceuticals, food & beverage, fine chemical, environment, etc. Our pumps have been exported to Germany, UK, USA, Australia, Russia, in total 95 countries.





SHENCHEN



BUILD IN 2006

2006

Innovation—the producer of easy load pump head with PPS material, solving the technical problem what the PSU material pump head can't bearing corrosion resistance.

- More than 13 years experience.
- R&D engineers take up 35% of company staff.
- 30% of the company's annual profits for R&D funds.
- The technology research center for peristaltic pump.

- Every year launch 2-3 new series products.
- All products are CE and Rohs certified.
- 21 patents, 4 software copyrights.



EXPORTED TO 95 COUNTRIES

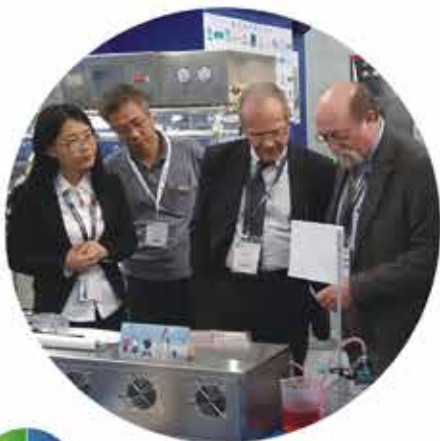
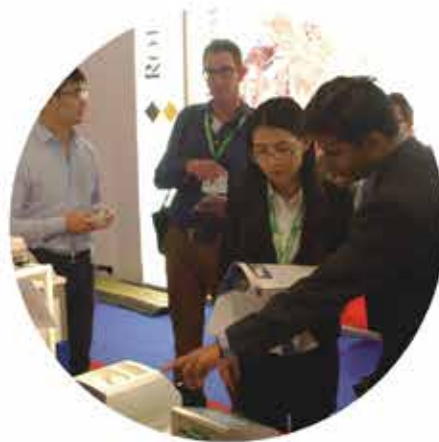
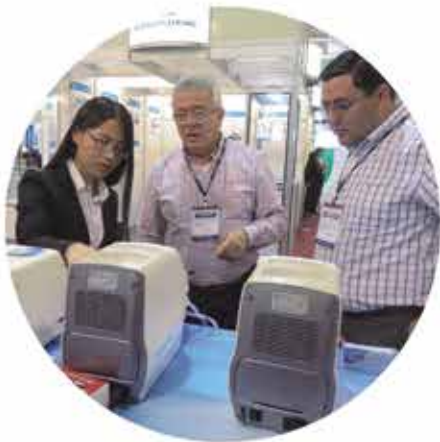
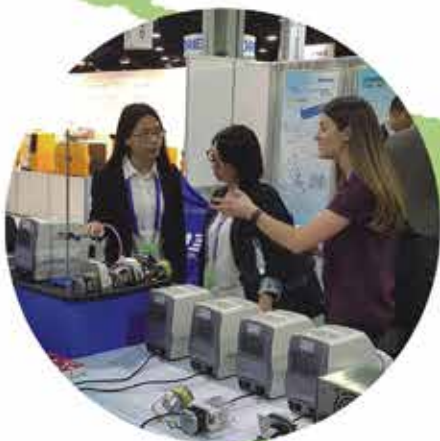



APPLICATION



Laboratory chemical dosing



Analytical instrument sampling



Waste water treatment



Chromatography



Cosmetic filling



Pharmaceutical filling



Food & Beverage filling



Reagents dispensing



**MINING AND
METALLURGY**



- 1 COMPANY
- 2 HONOR
- 3 APPLICATION
- 4 PRODUCTS



- ◆ OCM Fluid Solution..... 2
- ◆ Compact Peristaltic Pump..... 7
- ◆ Flow Rates Peristaltic Pump..... 10
 - LabN Series..... 10
 - LabV Series/V Series..... 12
 - V6 Series (servo motor) 14
 - External control function..... 15
- ◆ Lab-IV Peristaltic Pump 16
- ◆ Dispensing Peristaltic Pump..... 17
 - LabF Series/F Series..... 17
 - F6 Series (servo motor) 19
 - IF3 Low Pulsation (servo motor) 21
- ◆ Filling system..... 22
 - KF300..... 22
 - Split Type CF600/CF600 Plus..... 23
 - Split Type CF350/CF350 Plus (servo motor) 24
 - Integrated Type DF600/DF600 Plus..... 25
 - Integrated Type DF600IV/DF350 (servo motor) 26
- ◆ Standard Peristaltic Pump.....30
 - BT-N Series..... 30
 - N6 Series (servo motor) 31
- ◆ Basic Peristaltic Pump..... 32
 - LabM Series..... 32
 - BT-M Series..... 33
 - ZG600x..... 34
- ◆ Planetary Gear Industrial Pump..... 35
- ◆ Explosion Proof Peristaltic Pump..... 36
 - EXP600..... 36
 - QD600..... 37
- ◆ Hand Sampling Pump..... 38
- ◆ Compact Pump Head 39
- ◆ Multichannel Pump Head 46
- ◆ Easy Load Pump Head-YZ Serie..... 52
- ◆ Standard Pump Head-SN Series 56
- ◆ Fast Load Pump Head-DZ Series 58
- ◆ Spring Type Pump Head..... 60
- ◆ Low Pulse Pump Head-DY Series..... 61
- 5 Syringe Pump..... 65
- 6 Gear Pump..... 72
- 7 Piston Pump..... 73
- 8 Peristaltic Pump Tubing and Accessory..... 75



SHENCHEN

Pump Head
Flow Rate

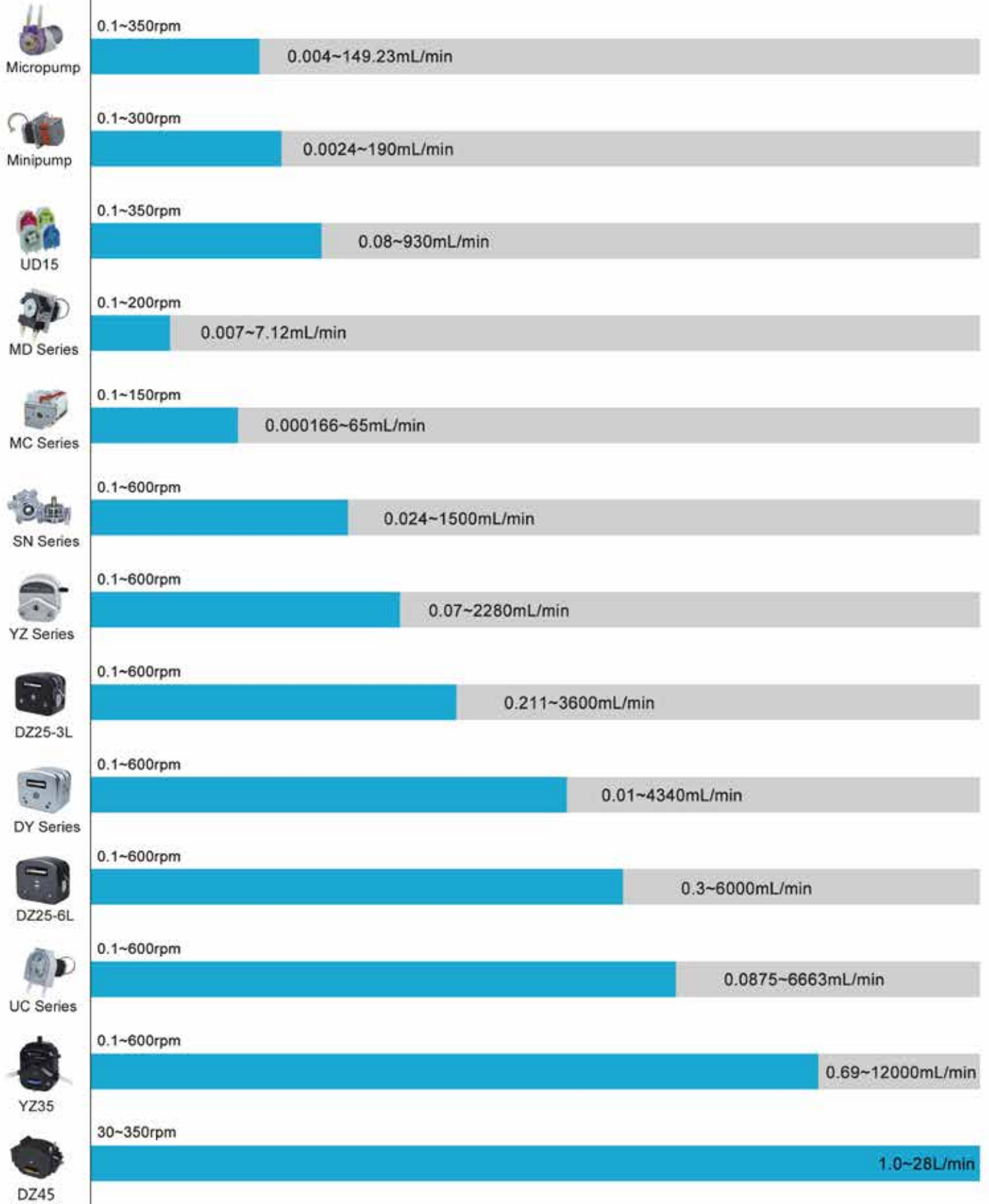

MicroPump

Beautiful appearance,
compact size, rich color, OEM ideal choice



SHEN CHEN PUMP

NEW ◆◆◆
PRODUCTS

ISPLab Series Intelligent Syringe Pump



Diluter & Dispenser System ASD60



HandyPump



Compact Peristaltic Pump
Model: LabK Series



Compact Peristaltic Pump
Model: LabS Series

What is OCM

OCM (Original Customized Manufacture)

- Peristaltic pump core technology
- One-to-one customization of services
- User-defined work mode



PROBLEMS

Conventional products can't be solved

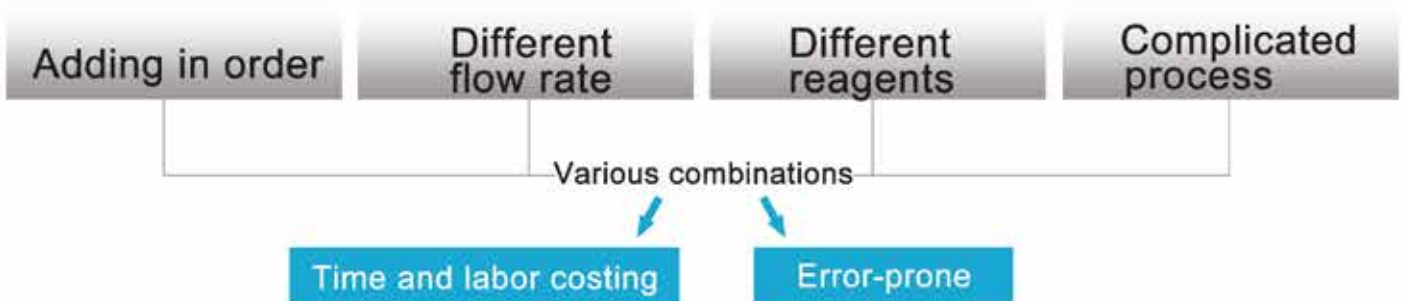

How to solve the problems?

OCM provides customized solutions for you.

- 1 Analyze problem
- 2 Design solution
- 3 Design OCM product

Our advantages

CUSTOMIZED Professional engineer offer one to one customized service.

EXPERIENCE 13 years of fluid transmission.

TECHNOLOGY Peristaltic pump technology research center.



OCM Application

01



01 Medical industry

Automatic liquid mixing system, intelligent proportional mixing of different liquids, the system can intelligently detect the liquid level of the barrel. Through the analysis of the liquid state of each barrel, control the start and stop of the peristaltic pump, open and close OF solenoid valve, so as to realize the automation of the work flow.

02



03



04



02 Printing and dyeing industry

Pigment accurate allocation, use several different pump heads to allocate different colors of pigment.

03 Pharmaceutical industry

Filling one bottle with several times during filling process to prevent foaming.

04 Customized system

With integrated design, a controller can control multiple peristaltic pump unit, which is convenient to realize unified operation.

05 WIFI control

WIFI connection, Android platform control software, make the peristaltic pump can be remote controlled by any intelligent terminal.

05



OCM Application

**06 Bio-pharmaceutical**

Work with reactor or fermentation tank, the OCM system add different liquids with proportion and order into reactor. Together accomplish adding liquid, mixing, reaction, dispensing, waste discharge and washing function.

**07 Research laboratory**

Customized OCM system, one controller with different pump heads and one pneumatic pump, with foot pedal switch control the pump start/stop.

**08 Food Industry**

Suitable for high temperature and high humidity working environment. High filling accuracy, the errors between each channels is $\pm 3\%$, non-pollution filling. Friendly operation interface, easy operation. Reversible, priming function.

**09 Textile industry**

48 channels MC series pump head with servo motor, special for micro flow rate and multichannel transferring.



BioD-I



INTRODUCTION

This product is an intelligent platform for automatic separation of nucleic acid detection reagents. It has achieved high precision automatic batch production of reagents.

FEATURES

8 different reagents are packed in unequal or equal amounts.

1

Up to 0.5% packing accuracy.

2

7 inch industrial true color LCD touch screen operation, man-machine interface is friendly, can store more than a group of commonly used work mode, simple and convenient.

3

The utility model has two-way quick liquid filling function, can be used for bidirectional operation and is convenient for cleaning the hose, and can quickly fill the reagent in the preparation stage or the packing line before and after the packing.

4

Mechanical arm operation program can be edited to apply different size, different shape of reagent box, accurate positioning, production efficiency.

5

APPLICATION

This product is used for gene testing reagent packing, microporous plate packing, reagent box packing, micro reagent packing, biological reagent packing and so on.



Gene testing reagent packing



Microporous plate packing



Reagent box packing



Micro reagent packing



Biological reagent packing



Programmable Filling System



Features

- | One controller can control maximum 8 pump units, each pump with same or different pump heads.
- | Four working modes:
 - Independent working mode,
 - independent and steps filling working mode,
 - logic working mode,
 - comprehensive working mode.

Model Number

- | PDSI, PDSII, PDSIII, PDSIV

Application 1

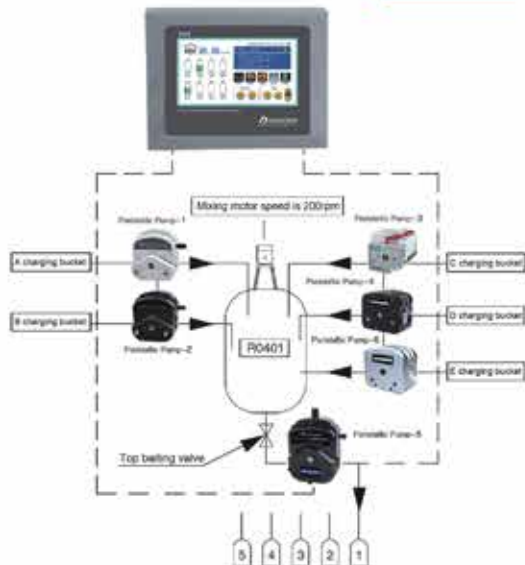

Application 1 Chemical industry: Reactor liquid adding, dispensing and washing, with different volume and adding liquid according to preset order.

Application 2



Application 2: PDSIV, one controller with 7 pump units, 4 minipump and 3 YZ1515x pump heads, for different liquid filling with different time sequence.

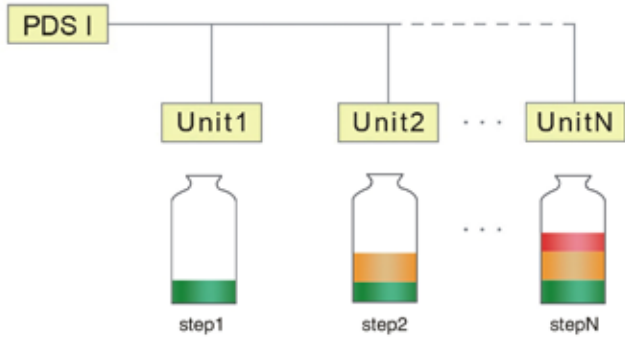

Logic working mode

In logic working mode, each unit working cooperatively. Filling or transferring with orders, also with different proportion adding, finish automation mixing work.

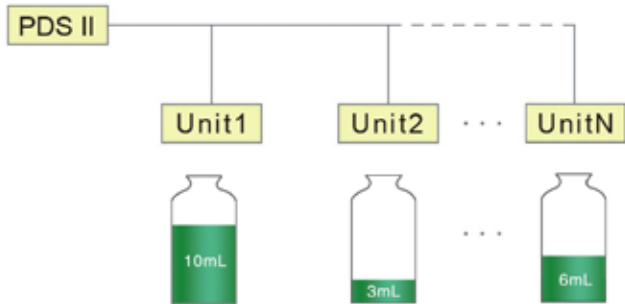

Independent working mode

In independent working mode, each unit working independently, can fill different volume.

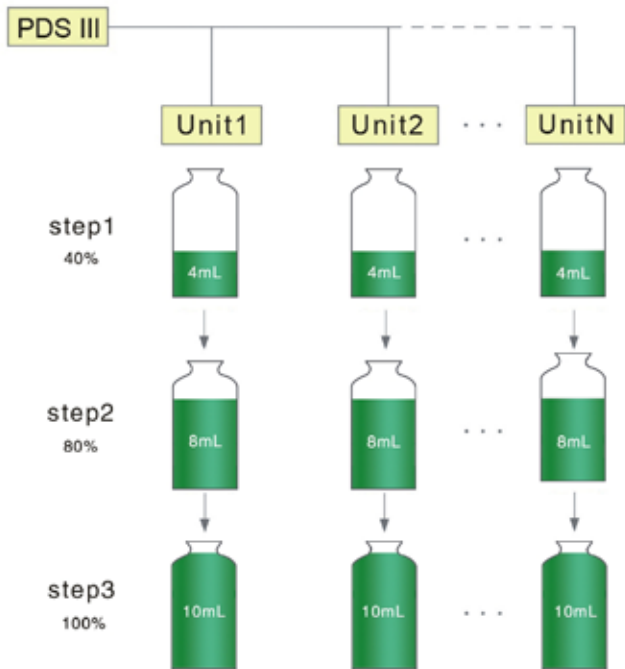

Independent and steps filling working mode

In independent working mode, each unit can finish filling process with multiple different filling volume. This function suitable for prevent fluid splashing and foaming. This process can also repeat many times, achieving complicated dispensing function.

PDS IV
comprehensive working mode

The comprehensive working mode include all the above functions.



Compact Peristaltic Pump

3 years warranty

LabK1, LabK3



Product Introduction

- | ABS engineering plastic housing, anti-corrosion, anti-static.
- | OLED screen display motor speed, digital knob control speed.
- | Compact design, various external control.
- | Easy to observe the pump head and tubing working situation.

Product Features

- | Low power consumption, mute working.
- | Stable flow rate and suitable for continuous dosing applications.
- | Easy to replace long life PharMed tubing.
- | Digital knob control speed, memory back up, user setting saved if power lost.

Dimension Drawing (Unit: mm)

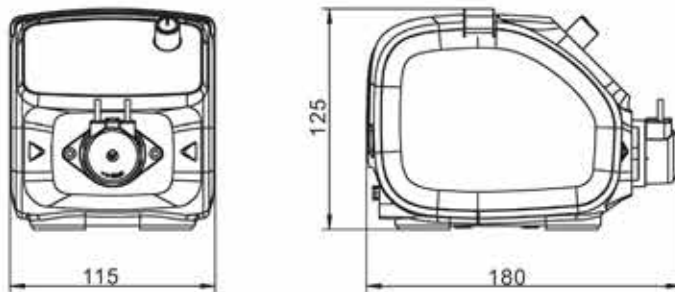

Color Selection



Technical Specifications

Flow rate range	0.004-149.23mL/min	External control	Start/stop direction control (switch signal) ,
Speed range	LabK1: 0.1-150rpm reversible LabK3: 0.1-350rpm reversible		0-5V, 4-20mA (standard) 0-10V (optional)
Speed resolution	0.1rpm	Power adapter	DC 12V/1A with power adapter
Speed control	Digital knob	Dimension	180*115*125mm (L×W×H)
Control method	Mechanical keypad	Weight	0.8kg
Keypad lifetime	300,000 times	Condition temperature	0-40℃
Display	0.96" OLED display	Relative humidity	< 80%
Communication interface	USB connector, RS485 interface (MODBUS protocol, RTU mode)	IP rate	IP31

Product Composition and Flow Rate Range

Model	Pump Head	Speed(rpm)	Tubing Size (ID×Wall Thickness(mm))	Flow Rate Range (mL/min)
LabK1	MicroPump	0.1-150	1*1, 2*1, 3*1, 4*1	0.004-63.96
LabK3		0.1-350		0.004-149.23



Compact Peristaltic Pump

3 years warranty

LabS1, LabS3



Product Introduction

- | ABS engineering plastic housing, anti-corrosion, anti-static.
- | OLED screen display motor speed, digital knob control speed.
- | Compact design, various external control.
- | Easy to observe the pump head and tubing working situation.

Product Features

- | Low power consumption, mute working.
- | Stable flow rate and suitable for continuous dosing applications.
- | Easy to replace long life PharMed tubing.
- | Digital knob control speed, memory back up, user setting saved if power lost.

Dimension Drawing (Unit: mm)

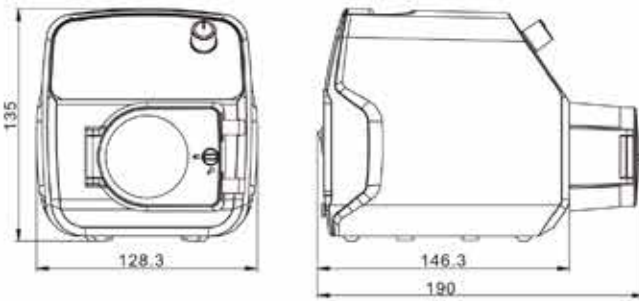

Pump Head

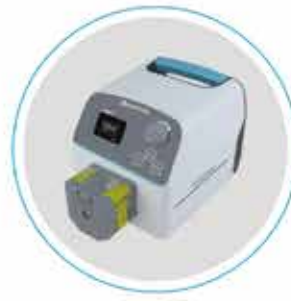

MiniPump



UD15

Technical Specifications

Flow rate range	0.0024-930mL/min	Communication interface	USB connector, RS485 interface (MODBUS protocol, RTU mode)
Speed range	LabS1/UD15: 0.1-150rpm reversible	External control	Start/stop direction control (switch signal) , 0-5V, 4-20mA (standard), 0-10V (optional)
	LabS1/Minipump: 0.1-100rpm reversible		
	LabS3/UD15: 0.1-350rpm reversible		
	LabS3/Minipump: 0.1-300rpm reversible	Power supply	DC 24V/1A with power adapter
Speed resolution	0.1rpm	Dimension	190*128.3*135mm (L*W*H)
Speed control	Digital knob	Weight	1.1kg
Control method	Mechanical keypad	Condition temperature	0-40°C
Keypad lifetime	300,000 times	Relative humidity	< 80%
Display	0.96" OLED display	IP rate	IP31

Product Composition and Flow Rate Range

Model	Pump Head	Speed(rpm)	Tubing Size	Flow Rate Range (mL/min)
LabS1	UD15	0.1-150	16", 25", 17"	0.08-398.57
	Minipump	0.1-100	1", 2", 2.5", 3", 13", 14", 16", 25"	0.0024-63.33
LabS3	UD15	0.1-350	16", 25", 17"	0.08-930
	Minipump	0.1-300	1", 2", 2.5", 3", 13", 14", 16", 25"	0.0024-190



Compact Peristaltic Pump

3 years warranty

SP-MiniPump



Features

- 304 stainless steel housing, resisting corrosion, space-saved.
- OLED screen, display the current motor speed and working status.
- Digital knob control speed, toggle switch control direction and start/stop.
- Various external control functions, support RS485 standard MODBUS protocol.

Dimension Drawing (Unit: mm)

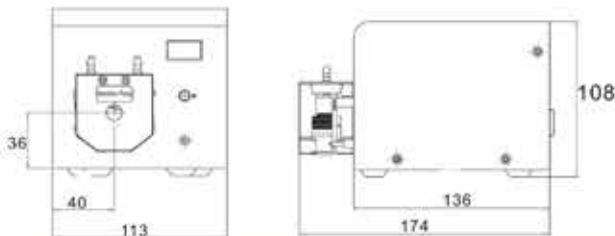

Model Number

SP-MiniPump01, SP-MiniPump02

External Control Schematic Diagram

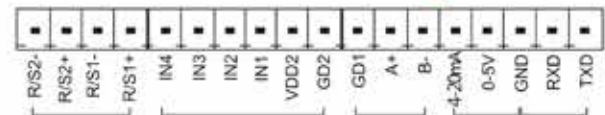

Technical Specifications

Flow rate range	0.0024~190 mL/min	Communication interface	RS485 support MODBUS protocol (RTU mode)
Speed range	0.1~300 rpm, reversible.	Power supply	24V/1A DC power
Speed resolution	0.1rpm	Drive dimension	136×113×108 mm (L×W×H)
Speed control	Digital knob control speed	Weight	1.64 kg
Motor type	Stepper motor	Power consumption	< 15 W
Display	OLED display	Condition temperature	0-40°C
External control	Start/stop control (switch signal)	Relative humidity	< 80%
	0-5V, 4-20mA(standard), 0-10V (optional)	IP rate	IP31

SP-MiniPump Speed/Flow Rate Reference

Rotation Speed (rpm)	Dual Channel Flow Rate (mL/min) and Tubing (1 mm wall thickness)			
	ID 1 mm	ID 2 mm	ID 2.5 mm	ID 3 mm
5	0.25	0.90	1.28	1.78
10	0.49	1.84	2.59	3.52
15	0.74	2.76	3.85	5.30
25	1.25	4.57	6.43	8.80
40	2.00	7.31	10.25	14.02
50	2.52	9.14	12.78	17.47
75	3.76	13.64	19.04	26.12
100	5.03	18.17	25.42	35.34
200	10.12	36.45	51.27	71.44
250	12.63	45.75	64.34	88.35
300	15.01	54.63	76.84	108.39
Rotation Speed (rpm)	Single Channel Flow Rate (mL/min) and Tubing (1.6 mm wall thickness)			
	13° Tubing ID 0.8 mm	14° Tubing ID 1.6 mm	16° Tubing ID 3.1 mm	25° Tubing ID 4.8 mm
5	0.12	0.56	1.97	3.26
10	0.26	1.15	3.90	6.41
15	0.39	1.74	5.80	9.52
25	0.66	2.88	9.59	15.74
40	1.08	4.59	15.29	25.15
50	1.34	5.69	18.96	31.14
75	2.00	8.54	28.36	46.55
100	2.73	11.37	37.66	61.98
200	5.46	22.76	76.02	124.14
250	6.81	28.40	95.08	153.63
300	8.28	33.88	114.31	190.00



Flow Rates Peristaltic Pump

LabN1, LabN3, LabN6

3 years warranty



Model Number

LabN1, LabN3, LabN6

LabN Series External Control Schematic Diagram

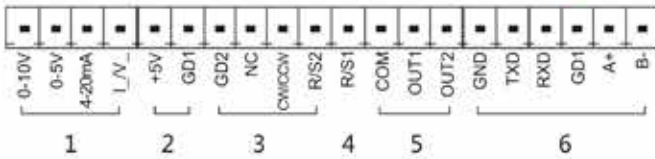

Suitable Pump Head



YZ1515x



YZ2515x



MC Series



DG Series

Features

- | 3.2" color LCD screen display.
- | Flow rate and motor speed display in same screen.
- | Timing function, time range 0.1s-9999 hours, can be used for simple dispensing function.

Typical Application

- | Special for university laboratory and research institute.
- | Ion chromatography and titrator
- | Pilot scale and industry production



LabN Series Interface and Keypad



Technical Specifications

Flow rate range	LabN1: 0.000166~570 mL/min LabN3: 0.000166~1330 mL/min LabN6: 0.000166~2280 mL/min	Start/stop, reversing signal	Passive switch signal, such as foot pedal Active switch signal: 5V,12V,24V for option
Speed resolution	0.1rpm	Communication interface	RS232, RS485 support Modbus protocol(RTU mode)
Back suction angle	0-360°	Output interface	Output motor working status (Open-Collector output)
Testing time range	0.1 s-9999 h	Power supply	AC 220V±10% 50Hz/60Hz (standard) AC 110V±10% 50Hz/60Hz (optional)
Outlet pressure	0.8~1.0 mm wall thickness tubing: 0.1Mpa; 1.6~2.4mm wall thickness tubing: 0.1~0.27Mpa	Drive dimension	261.4×157.3×236.9mm
Display	3.2" high definition LCD screen	Drive weight	4.40 kg
Control method	Knob speed and Mechanical keypad	Power consumption	< 50W
Keypad lifetime	300,000 times	Condition temperature	0-40°C
External speed control signal	0-5V, 0-10V, 4-20mA for option	IP rate	IP31
Relative humidity	< 80%		

Product Composition and Flow Rate Range

Standard Peristaltic Pump		Pump Head & Flow Rate (mL/min)			
		YZ1515x	YZ2515x	MC1~MC12(10)	MC1~MC12(6)
Drive & speed	Tubing	13', 14', 19', 16', 25', 17', 18'	15', 24'	Inner diameter: 0.13-3.17mm Wall thickness: 0.8-1mm	
LabN1	0.1-150rpm	0.007~570	0.17~435	0.000166-49(suggestion working speed ≤ 150rpm)	0.000185-65(suggestion working speed ≤ 150rpm)
LabN3	0.1-350rpm	0.007~1330	0.17~1015		
LabN6	0.1-600rpm	0.007~2280	0.17~1740		

Application



Flow Rates Peristaltic Pump

LabV1, LabV3, LabV6

3 years warranty



LabV1, LabV3, LabV6

Laboratory

Industrial equipment supporting

Suitable Pump Head



YZ1515x



YZ2515x



MC Series



DG Series

Industrial grade 4.3" true color LCD screen, touch screen control, both Chinese and English interface available.

Dynamic display transferring status. Flow rate data, setting parameters and system configuration display in the same screen.

3 Kinds of working mode: fixed volume metering, fixed time and volume, timer start and stop, meet different transferring and dispensing request.

Intelligent calibration function and online micro adjusting function.

Flow Rates Peristaltic Pump

V1, V3, V6

3 years warranty



V1, V3, V6

Laboratory

Industrial equipment

External Control Schematic Diagram

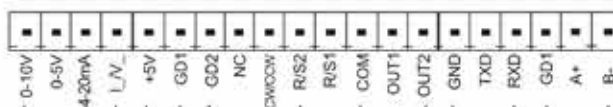

Technical Specifications

Flow rate range	LabV1/ V1: 0.000166~570 mL/min LabV3/ V3: 0.000166~1330 mL/min LabV6/ V6: 0.000166~2280 mL/min	Start/stop, direction signal	Passive switch signal, such as foot pedal switch Active switch signal: 5V, 12V and 24V for option
Speed range	0.1-600 rpm	Communication interface	RS232, RS485 support MODBUS protocol (RTU mode) , Output motor working status
Speed resolution	0.01 rpm	Output interface	(Open-Collector output)
Flow rate resolution	0.01 µl	Power supply	AC 220V±10% 50Hz/60Hz (standard) AC 110V±10% 50Hz/60Hz (optional)
Flow rate accuracy	<±0.5%	Drive dimension (L×W×H)	LabV Series: 261.4×157.3×236.9 mm V Series: 219.6×152×211.6 mm
Back suction angle	0-360°	Drive weight	LabV Series: 4.40 kg V Series: 4.20 kg
Outlet pressure	0.1Mpa (0.8-1.0mm wall thickness tubing) 0.1-0.27Mpa (1.6-2.4mm wall thickness tubing)	Power consumption	< 50W
Motor type	Stepper motor	Condition temperature	0-40℃
Display	Industrial grade 4.3" LCD color display	Relative humidity	< 80%
Control method	Touch screen and Mechanical keypad	IP rate	IP31
Keypad lifetime	300,000 times		
External speed control signal	0-5V, 0-10V, 4-20mA for option		

Product Composition and Flow Rate Range

Flow Rates Peristaltic Pump		Pump Head & Flow Rate (mL/min)			
Tubing		YZ1515x	YZ2515x	MC1-MC12(10)	MC1-MC12(6)
Drive & speed		13", 14", 19", 16", 25", 17", 18"	15", 24"	Inner diameter: 0.13-3.17mm Wall thickness: 0.8-1mm	
LabV1/V1	0.1-150rpm	0.007~570	0.17~435	0.000166-49(suggest working rotating speed≤150rpm)	0.000185-65(suggest working rotating speed≤150rpm)
LabV3/V3	0.1-350rpm	0.007~1330	0.17~1015		
LabV6/V6	0.1-600rpm	0.007~2280	0.17~1740		

Flow rate Setting Interface

External Control Speed Setting Interface

Fixed Volume Measurement Setting Interface

Fixed Time and Volume Setting Interface

Timer Start and Stop Setting Interface



Flow Rates Peristaltic Pump

3 years warranty



Features

- Large flow rate, high precision, intelligent control of liquid transferring.
- Servo motor drive, accurate control, strong driving force.
- 304 stainless steel housing, the first choice for high level industrial sites.

Model Number

- V6-3L/DZ25-3L
- V6-6L/DZ25-6L
- V6-12L/YZ35

Technical Specifications

Flow rate range	V6-3L: 0.211~3600 mL/min V6-6L: 0.3~6000 mL/min V6-12L: 0.00069~12 L/min	Start/stop,direction signal	Passive switch signal, such as foot pedal switch Active switch signal: 5V, 12V and 24V for option
Speed range	0.1-600 rpm	Communication interface	RS232, RS485 support MODBUS protocol (RTU mode)
Speed resolution	0.01 rpm	Output interface	Output motor working status (Open-Collector output)
Flow rate resolution	0.01 mL	Power supply	AC 220V±10% 50Hz/60Hz (standard) AC 110V±10% 50Hz/60Hz (optional)
Flow rate accuracy	<±0.5%	Drive dimension	V6-3L: 223×152×200mm V6-6L: 283×192×218mm V6-12L: 302×222×275mm
Back suction angle	0-360°	Drive weight	V6-3L: 5.02kg; V6-6L: 7.85kg; V6-12L: 13.14kg
Outlet pressure	0.3 Mpa	Power consumption	V6-3L: <80W ; V6-6L: <180W ; V6-12L: <300W
Motor type	Servo motor	Environment temperature	0-40°C
Display	Industrial grade 4.3" color LCD display	Relative humidity	< 80%
Control method	Touch screen and Mechanical keypad	IP rate	IP31
Keypad lifetime	300,000 times		
External speed control signal	0-5V,0-10V,4-20mA for option		

Product Composition and Flow Rate Range

Drive	Motor Type	Pump Head	Tubing Size	Speed Range(rpm)	Flow Rate(mL/min)
V6-3L	Servo Motor	DZ25-3L	15", 24", 35", 36"	0.1-600	0.211~3600
V6-6L		DZ25-6L	15", 24", 35", 36"		0.3~6000
V6-12L		YZ35	26", 73", 82"		0.69~12000



V Series peristaltic pump has various external control interface, can meet different equipment supporting requirements.

External control interface definition

1. Analog signal input port: Choose the external control speed signal from the external control setting interface. Turn on the external control speed function, control the motor speed range through the analog signal.
2. Internal isolation 5VDC output.
3. External control start/stop,direction signal input port: active signal input.
4. R/S1 external control start/stop signal input port: passive signal input.
5. Motor running status output port: output current running status of the motor.
6. RS232 communication interface: choose RS232 in communication setting interface, this port is effective.
7. RS485 communication interface: choose RS485 in communication setting interface, this port is effective.



V Series peristaltic pump external control setting interface.

Choose external control start/stop,direction signal

1. Can respectively set external control start/stop or reversing switch whether effective or not.
2. Can choose control mode according to requirement: pulse mode or level mode.
3. Can set the foot switch whether effective or not.
4. Can choose switch value signal 's high level values according to customers' main control equipment: 5V(default), 12V,24V.

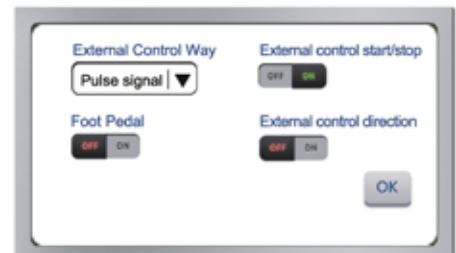

Programmable external control speed setting

1. Can choose analog signal source according to requirements: 0-5V, 0-10V, 4-20mA.
2. When the signal source is chosen, can choose maximum speed and minimum speed which corresponding to the signal source's maximum value and minimum value according to actual demand, to reach userdefined rotate speed range purpose.
3. Working speed limit is at the situation that the linear relation of analog quantity signal and rotating speed keeps invariant, set peristaltic pump's maximum working rotate speed. This setting can avoid production accident caused by sudden change of transfer fluid amount with the sudden change of external analog signal.



Communication setting

1. Support RS232 and RS485 interface, can be chosen in software interface.
2. Support various Baud rate : 2400bps, 4800bps, 9600bps, 19200bps.
3. Can choose standard modbus communication protocol or Shenchen communication protocol to control, modbus communication protocol is suitable to match with industrial site HMI, PLC or other upper computer which support standard modbus communication protocol; Shenchen communication protocol is suitable to match with single chip micro computer or upper computer on computer programme.

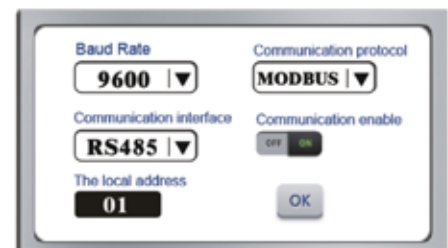

Dimension Drawing (Unit: mm)

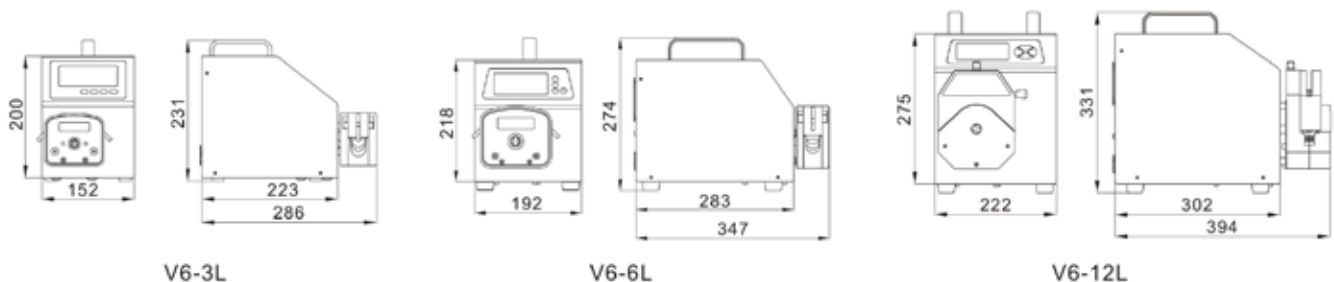

Flow Rates Peristaltic Pump

LabV6-IV, LabF6-IV, LabN6-IV, LabM6-IV



Features

- | With ABS engineering plastic housing, streamlined body design.
- | Servo motor control, more strong and precise .
- | Large flow rate range with UC25 pump head.

Model Number

- | LabV6-IV, LabF6-IV, LabN6-IV, LabM6-IV

Typical Application

- | Mainly for laboratory.

Product Composition and Flow Rate Range

Model	Pump Head	Speed Range(rpm)	Tubing Size	Flow Rate (mL/min)
LabV6-IV	UC25	0.1-600	15", 24", 35", 36"	0.3423~6663
LabF6-IV		1-600		3.423~6663
LabN6-IV		0.1-600		0.3423~6663
LabM6-IV		0.5-600		1.7115~6663

Technical Specifications

Outlet pressure	0.14~0.27Mpa	Power supply	AC 220V ± 10% 50Hz/60Hz(standard) AC 110V ± 10% 50Hz/60Hz(optional)
Motor type	Servo motor	Drive dimension	261.4 × 157.3 × 236.9mm
Communication interface	LabV6-IV/LabF6-IV/LabN6-IV: RS232, RS485 support MODBUS protocol (RTU mode); LabM-IV: RS232(standard), Shenzhen communication protocol; RS485(optional), Modbus protocol (RTU mode)	Drive weight	4.40kg
		Power consumption	<80W
		Condition temperature	0~40℃
		Relative humidity	<80%
		IP rate	IP31

Drive	Model	Display	Operating mode	External control signal	Motor Status Output Interface
LabV6-IV	Intelligent flow rate type	4.3"-industrial-true color LCD Screen	Touch screen + Mechanical keypad	External speed control signal: 0-5V, 0-10V, 4-20mA for option; Start/Stop: Passive switch signal, such as foot pedal; Active switch signal: 5V(standard), 12V, 24V(optional)	open-collector output
LabF6-IV	Intelligent dispensing type	4.3"-industrial-true color LCD Screen	Touch screen + Mechanical keypad	Start/Stop: Passive switch signal, such as foot pedal; Active switch signal: 5V, 12V(optional), 24V(standard)	open-collector output
LabN6-IV	Standard type	3.2"LCD Screen	Mechanical keypad	External speed control signal: 0-5V, 0-10V, 4-20mA for option; Start/Stop: Passive switch signal, such as foot pedal; Active switch signal: 5V(standard), 12V, 24V(optional)	open-collector output
LabM6-IV	Basic type	3 digital LED	Mechanical keypad	External speed control signal: 0-5V(standard), 0-10V,4-20mA(optional); Start/Stop: Passive switchsignal, such as foot pedal; Active switch signal:5V, 12V(optional), 24V(standard)	No



Dispensing Peristaltic Pump

LabF1, LabF3, LabF6

3 years warranty



- Medicine and chemical dispensing, such as oral liquid, diagnostic reagents.
- Cosmetic dispensing, such as perfume, lip gloss.



Handling Dispenser

- Based on ergonomics engineering design
- Elegant appearance

Accessories



- ① Filling Countersunk
- ② Filling Nozzle
- ③ Foot Pedal Switch

Features

- Imported 4.3" industrial grade color LCD screen display, with touch screen control.
- Can preset dispensing volume, dispensing time, pause time and copy numbers.
- With intelligent calibration function and online micro adjusting function.
- The pump can store 60 commonly used filling modes.
- Back suction angle setting, avoid liquid drop off when the pump stops working.
- New flow rate mode, can be used for continuous transferring.
- Can communicate with balance, closed-loop control.

Dispensing Peristaltic Pump

F1, F3, F6

3 years warranty



Model Number

| F1, F3, F6

External Control Schematic Diagram

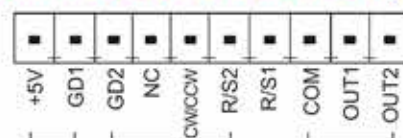

Technical Specifications

Flow rate range	LabF1/F1: 0.00166~570mL/min LabF3/F3: 0.00166~1330mL/min LabF6/F6: 0.00166~2280mL/min	Keypad lifetime	300,000 times
Speed range	1-600rpm	Start/stop, direction signal	Passive switch signal, such as foot pedal switch Active switch signal: 5V, 12V and 24V for option
Speed resolution	0.01rpm	Output interface	Output motor working status (Open-Collector output)
Dispensing volume range	0.1-9999.99mL	Communication interface	RS232, RS485 support Modbus protocol (RTU mode)
Dispensing volume resolution	0.01mL	Power supply	AC 220V±10% 50Hz/60Hz (Standard) AC 110V±10% 50Hz/60Hz (Optional)
Dispensing time	0.1-9999.99s	Outlet pressure	0.1Mpa(0.8~1.0mm wall thickness tubing) 0.1~0.27Mpa(1.6~2.4mm wall thickness tubing)
Pause time	0.1-9999.99s	Drive dimension (L×W×H)	LabF Series: 261.4×157.3×236.9 mm F Series: 219.6×152×211.6mm
Time resolution	0.01s	Drive weight	LabF Series: 4.40 kg F Series: 4.20 kg
Copy numbers	1-9999 times, setting '0' means unlimited	Power consumption	<50W
Back suction angle	0-360°	Condition temperature	0-40°C
Dispensing accuracy	<±0.5%	Relative humidity	<80%
Motor type	Stepper motor	IP rate	IP31
Display	Industrial grade 4.3" color LCD display		
Control method	Touch screen and Mechanical keypad		

Product Composition and Flow Rate Range

Dispensing Peristaltic Pump		Pump Head & Flow Rates (mL/min)			
		YZ1515x	YZ2515x	MC1-MC12(10)	MC1-MC12(6)
Drive & speed	Tubing	13", 14", 19", 16" 25", 17", 18"	15", 24"	Inner diameter: 0.13-3.17mm Wall thickness: 0.8-1mm	
LabF1/F1	1-150rpm	0.07~570	1.7~435	0.00166-49(suggestion working speed≤150rpm)	0.00185-65(suggestion working speed≤150rpm)
LabF3/F3	1-350rpm	0.07~1330	1.7~1015		
LabF6/F6	1-600rpm	0.07~2280	1.7~1740		



Volume dispensing interface



Speed dispensing interface



Repeat numbers interface



Dispensing Peristaltic Pump



Features

- Suitable for large flow rate, high efficiency, high precision filling.
- Servo motor drive, accurate control, strong driving force.
- 304 stainless steel drive housing can support the filling line.
- New flow rate mode, can be used for continuous transferring.

Model Number

- F6-3L/DZ25-3L
- F6-6L/DZ25-6L
- F6-12L/YZ35

Technical Specifications

Flow rate range	F6-3L: 2.11~3600 mL/min F6-6L: 3.0~6000 mL/min F6-12L: 0.0069~12 L/min	Control method	Touch screen and Mechanical keypad
Speed range	1-600 rpm	Keypad lifetime	300,000 times
Speed resolution	0.01 rpm	Start/stop, direction signal	Passive switch signal, such as foot pedal switch Active switch signal: 5V, 12V and 24V for option
Dispensing volume range	0.1-9999.99 mL	Output interface	Output motor working status (Open-Collector output)
Dispensing volume resolution	0.01 mL	Communication interface	RS232, RS485 support Modbus protocol (RTU mode)
Dispensing time	0.1-9999.99 s	Power supply	AC 220V±10% 50Hz/60Hz (Standard) AC 110V±10% 50Hz/60Hz (Optional)
Pause time	0.1-9999.99 s	Drive dimension	F6-3L: 223×152×200mm F6-6L: 283×192×218mm F6-12L: 302×222×275mm
Time resolution	0.01 s	Drive weight	F6-3L: 5.02kg; F6-6L: 7.85kg; F6-12L: 13.14kg;
Copy numbers	1-9999 times, setting '0' means unlimited	Power consumption	F6-3L: < 80W ; F6-6L: < 180W ; F6-12L: < 300W
Back suction angle	0-360°	Condition temperature	0-40°C
Outlet pressure	0.3 Mpa	Relative humidity	< 80%
Dispensing accuracy	<±0.5%	IP rate	IP31
Motor type	Servo motor		
Display	Industrial grade 4.3" color LCD display		

Product Composition and Flow Rate Range

Drive	Motor Type	Pump Head	Tubing Size	Speed Range(rpm)	Flow Rate(mL/min)
F6-3L	Servo Motor	DZ25-3L	15", 24", 35", 36"	1-600	2.11~3600
F6-6L		DZ25-6L	15", 24", 35", 36"		3.0~6000
F6-12L		YZ35	26", 73", 82"		6.9~12000



LabF6/F6 Filling Volume Reference Parameter(Media is water)

Drive	Pump Head	Tubing	Filling Volume (mL)	Filling Time(s)	Filling Accuracy (±%)	Output(pcs/min)	Motor Speed(rpm)
LabF6/F6	YZ1515x YZ2515x	13 ^a	0.1	0.5	±5ul	40	204.083
		13 ^a	0.3	0.7	1.5	35	426.251
		13 ^a	0.5	1	0.8	30	516.081
		13 ^a	1	2	0.5	20	517.152
		14 ^a	2	1	1	30	446.724
		14 ^a	3	1.5	0.8	24	446.479
		19 ^a	5	1.2	1	27	454.919
		16 ^a	7	1	0.5	30	457.705
		25 ^a /15 ^a	10	1	1	30	303.426
		25 ^a /15 ^a	15	1	0.8	30	461.273
		25 ^a /15 ^a	20	1.2	0.5	27	518.945
		17 ^a /24 ^a	30	1.2	0.8	27	462.725
		17 ^a /24 ^a	50	2	0.5	20	461.595
		18 ^a	80	2.5	0.5	17	427.274
18 ^a	100	3	0.5	15	446.583		
F6-3L	DZ25-3L	15 ^a	16	1	0.5	30	443.540
		24 ^a	30	1.2	1.0	27	454.877
		35 ^a	150	4	0.6	12	447.940
		36 ^a	200	4	0.6	12	481.802
F6-6L	DZ25-6L	15 ^a	80	4	0.4	12	396.800
		24 ^a	150	4	0.4	12	440.700
		35 ^a	200	3.2	0.5	14	439.540
		36 ^a	300	3.5	0.5	13	473.208
F6-12L	YZ35	26 ^a	150	3	0.5	15	423.254
		73 ^a	300	3	0.5	15	457.805
		82 ^a	500	3	0.5	15	458.451

F6 Series Filling Accuracy Reference Parameter(Media is water)

Drive	Pump Head	Tubing	Filling Volume	Filling Time	Actual Filling Volume(mL)										Filling Accuracy				
					1	2	3	4	5	6	7	8	9	10	11	12	13	14	15
F6-3L	DZ25-3L	15 ^a	16mL	1s	15.97	15.97	16.00	16.06	15.97	15.92	15.96	16.02	16.01	15.97	-0.50%	0.50%			
					15.98	16.00	16.04	16.08	15.92	15.95	16.01	16.01	15.97	15.97					
		24 ^a	30mL	1.2s	29.98	30.12	30.20	30.29	30.06	29.94	30.11	30.18	30.02	29.99	-0.20%	1.00%			
					30.23	30.24	30.12	29.99	30.12	30.23	30.20	30.30	30.19	30.11					
F6-6L	DZ25-6L	35 ^a	150mL	4s	149.50	149.50	150.10	150.00	149.80	149.00	149.70	149.50	150.10	149.60	-0.15%	0.60%			
					149.00	149.90	149.70	149.10	149.50	150.00	150.10	150.10	149.60	149.40					
		36 ^a	200mL	4s	199.70	200.30	200.10	200.30	200.00	200.00	200.70	200.80	200.70	200.40	-0.67%	0.07%			
					200.30	200.00	200.30	200.80	200.90	200.70	200.80	200.40	200.50	200.20					
F6-12L	YZ35	26 ^a	150mL	3s	80.2	80.0	80.3	80.2	80.1	80.1	80.2	80.1	80.2	80.1	-0.125%	0.375%			
					80.1	79.9	80.1	79.9	80.0	80.1	19.9	80.1	80.1	80.0					
		73 ^a	300mL	3s	149.9	150.2	150.0	150.1	150.0	150.3	150.0	150.1	150.3	150.0	-0.067%	0.200%			
					149.9	150.1	150.0	150.0	150.1	150.0	150.1	149.9	150.2	150.2					
82 ^a	500mL	3s	199.7	199.9	200.2	200.2	200.2	199.6	199.8	199.8	200.1	199.9	-0.400%	0.100%					
			199.5	199.2	199.5	199.9	199.5	199.3	199.8	199.3	199.6	199.9							
F6-12L	YZ35	26 ^a	150mL	3s	300.4	300.1	300.3	300.3	300.4	300.1	300.3	300.4	300.6	300.2	-0.167%	0.200%			
					300.2	300.0	300.1	300.2	300.2	299.9	299.5	300.5	300.5	300.6					
		73 ^a	300mL	3s	149.3	150.3	149.6	150.2	150.5	150.1	150.5	150.1	150.5	150.0	-0.47%	0.33%			
					150.4	149.9	150.4	150.0	150.3	149.8	150.3	149.9	150.4	150.0					
82 ^a	500mL	3s	299.9	299.8	300.0	300.1	300.4	300.2	300.4	300.4	300.6	300.5	-0.07%	0.27%					
			300.8	300.6	300.5	300.5	300.5	300.6	300.7	300.5	300.6	300.6							
82 ^a	500mL	3s	500.0	497.8	499.7	498.3	498.4	499.5	498.2	499.7	499.2	498.4	-0.44%	0.38%					
			499.5	498.3	501.5	501.9	500.0	501.8	501.1	500.5	501.6	499.6							



Low Pulsation Dispensing Peristaltic Pump

3 years warranty

304
SS Housing



IF3

Features

Servo motor drive, high precision, low pulsation dispensing peristaltic pump.

The low pulsation pump head is special for high precision filling. Through the phase difference between the two sets of rollers, make the fluid peaks and valleys complementary, then reduce the pulsation of the fluid.

Adaptive pressure tubing space, extend the tubing lifetime effectively.

Achieving high precision dispensing of micro flow rate.

New flow rate mode, can be used for continuous transferring.

Can communicate with balance, closed-loop control.

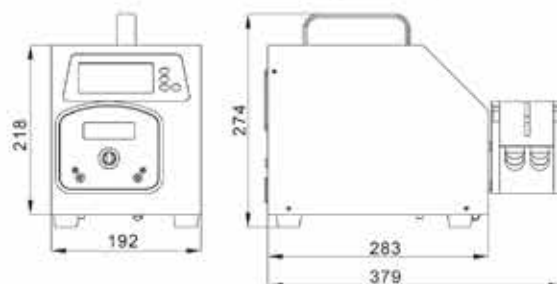

Model Number | IF3

Dimension Drawing (Unit: mm)

Product Composition and Flow Rate Range

Drive	Motor Type	Pump Head	Tubing	Speed Range(rpm)	Flow Rate(mL/min)
IF3	Servo motor	DY15	13', 14', 19', 16', 25', 17', 18'	1-350	0.1~3337
		DY25	15', 24', 35', 36'		4.2~4340

Filling Volume Reference Parameter(Media is water)

Tubing	Filling Volume	Filling Time	Actual Filling Volume(mL)										Filling Accuracy	
			1	2	3	4	5	6	7	8	9	10	1	2
14'	0.5mL	0.5s	0.5003	0.5010	0.4982	0.5015	0.5015	0.5010	0.5014	0.5005	0.4981	0.4998	-0.37%	0.32%
			0.5025	0.4983	0.5024	0.5021	0.5020	0.5004	0.5005	0.4997	0.4977	0.5008		
14'	1mL	1s	1.0037	1.0000	1.0026	1.0003	1.0031	1.0015	1.0000	1.0007	1.0023	1.0035	-0.44%	0.42%
			1.0002	1.0020	0.9968	1.0010	0.9986	1.0026	1.0030	1.0029	1.0023	1.0017		
14'	2mL	1s	2.0020	2.0060	2.0039	2.0037	2.0047	1.9944	2.0062	2.0040	1.9951	2.0060	-0.58%	0.60%
			2.0036	1.9940	2.0024	2.0086	1.9946	2.0005	1.9951	2.0068	1.9971	1.9965		
19'	3mL	1s	3.0058	2.9935	3.0092	3.0008	2.9927	3.0072	3.0046	2.9914	3.0040	3.0000	-0.33%	0.31%
			2.9902	3.0048	3.0008	2.9919	2.9984	3.0012	3.0084	2.9915	2.9990	3.0051		
16'	5mL	1s	5.0215	4.9982	5.0145	5.0038	4.9864	5.0183	4.9962	5.0227	5.0158	4.9806	-0.39%	0.50%
			5.0248	5.0070	4.9861	5.0108	4.9995	5.0080	5.0044	4.9868	5.0231	4.9977		
25'	10mL	1s	10.02	10.04	10.00	9.98	10.02	10.03	10.04	10.04	10.01	9.99	-0.20%	0.40%
			10.00	10.02	10.02	10.04	9.99	9.98	10.00	10.04	10.02	10.03		
25'	15mL	1s	15.02	14.97	14.97	14.94	15.00	15.00	14.94	14.95	14.96	14.99	-0.47%	0.13%
			14.96	14.95	14.96	14.99	14.98	14.94	14.93	14.93	14.98	14.96		
17'	30mL	1s	29.92	30.01	29.99	29.91	29.83	29.86	29.91	29.91	29.91	29.89	-0.57%	0.20%
			29.88	29.96	30.03	30.06	30.02	30.02	30.06	29.96	29.96	29.83		
18'	100mL	2.5s	99.80	99.90	99.80	99.90	100.00	100.10	100.10	100.00	100.10	100.00	-0.20%	0.30%
			99.80	100.00	100.10	100.20	99.90	100.10	100.00	100.30	100.10	100.10		
15'	10mL	1s	9.97	10.01	9.96	9.98	10.01	9.96	9.97	9.99	9.96	9.96	-0.60%	0.10%
			10.00	9.94	9.97	10.00	9.96	9.97	10.00	10.00	10.01	9.97		
24'	30mL	1s	29.90	29.80	30.10	29.90	29.90	30.00	29.90	29.90	30.00	29.90	-0.67%	0.33%
			29.90	29.90	29.90	29.90	29.90	29.80	30.00	29.90	29.90	30.00		
35'	70mL	1.2s	69.80	69.90	69.90	69.90	69.70	70.10	70.00	69.70	69.90	69.90	-0.43%	0.43%
			69.90	70.10	70.00	69.90	70.30	69.70	70.10	69.70	69.70	69.90		
36'	100mL	2s	99.80	99.90	99.80	99.80	100.00	99.90	99.90	99.90	99.90	99.90	-0.20%	0.10%
			99.80	99.90	99.90	99.90	100.00	100.10	99.80	100.10	99.90	99.90		



Desktop Filling System

KF300



The control unit

Typical Application

- | Laboratory liquid distribution
- | Diagnostic reagent components
- | Medium dispensing

Features

- | Integrated design, a controller can control 1-32 units.
- | Compact structure, compact size, beautiful appearance and saving space
- | Suitable for high precision micro liquids filling in laboratory.

Dimension Drawing (Unit: mm)

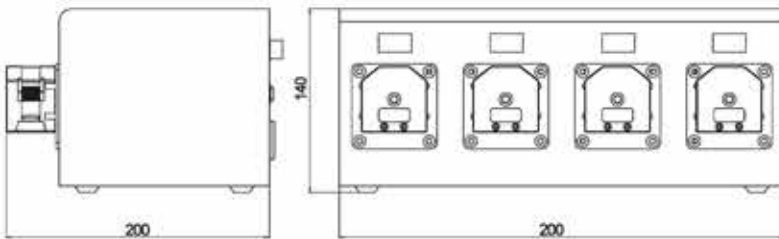

Drive Dimension Drawing

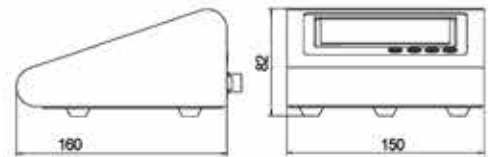

Controller Dimension Drawing

Technical Specifications

Speed range	1-300 rpm	Control mode	Touch screen and Mechanical keypad
Filling volume	0.01-9999.99 ml	Start/stop, direction signal	Passive switch signal, such as :foot pedal switch; Active switch signal, 5V, 12V, 24V for options
Dispensing time	0.1-9999.99 s		
Interval time	0.1-9999.99 s	Output interface	Output motor working status (Open-collector output)
Volume resolution	0.01 ml		
Time resolution	0.01 s	Communication interface	RS485 support Modbus protocol (RTU mode)
Copy numbers	1-9999 times, 0 represent unlimited		
Back suction angle	0-360°	Power supply	AC 220V±10% 50Hz/60Hz(standard) AC 110V±10% 50Hz/60Hz (optional)
Filling accuracy	<±0.5%		
Filling units	1-32 units	Condition Temperature	0-40°C
Display	4.3"Industrial grade -color LCD display	Relative humidity	<80%
Keypad lifetime	300,000 times	IP rate	IP31



Split Type Filling system



Features

- | Split design, adding or deleting filling units freely.
- | One controller can control 1-16 filling units.
- | Each filling unit can receive stop filling signal when bottle absent.
- | You can check the working status of the filling units from controller.

Model Number

- | CF600, CF600 Plus, CF600II, CF600II Plus

Typical Application

- | Laboratory dispensing
- | Industry filling

External Control Schematic Diagram

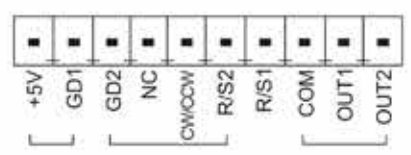

Dimension Drawing (Unit: mm)

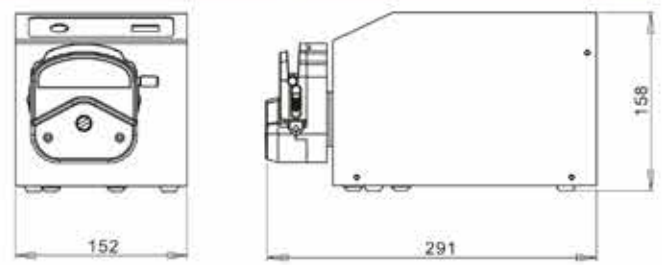

Drive Dimension Drawing

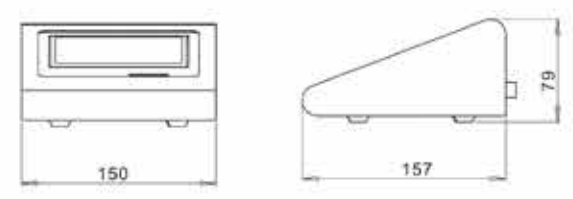

Controller Dimension Drawing



Split Type Filling System

CF350



Features

- | Servo motor drive, precision control
- | Split type design, space-saving, easy installation.
- | Use low pulsation pump head to reduce the pulsation of the fluid effectively.
- | Suitable for micro volume high precision filling.

Model Number

- | CF350, CF350 Plus, CF600III
- | CF600 PlusIII, CF600IV, CF600 PlusIV



Control Unit

Filling Unit

Dimension Drawing (Unit: mm)

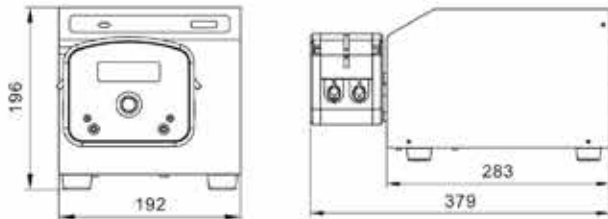

Drive Dimension Drawing

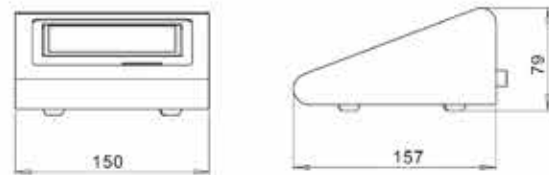

Controller Dimension Drawing

The pump type suffixed with "Plus" support MODBUS communication protocol.

Drive	Pump Head	Flow Rate (mL/min)	Motor Type	Drive Dimension (L×W×H)	Power Consumption	Drive Weight
CF600 CF600Plus	YZ1515x	0.07-2280	Stepper motor	237.4×152×158mm	Each unit < 50W	4.2kg
	YZ2515x	1.7-1740				
CF600 II CF600Plus II	DZ25-3L	2.11-3600	Stepper motor	237.4×152×158mm	Each unit < 80W	4.95kg
		3.0-6000				
CF600 III CF600Plus III	DZ25-6L	3.0-6000	Servo motor	283×192×196mm	Each unit < 180W	7.8kg
CF350 CF350Plus	DY15	0.1-3337	Servo motor	283×192×196mm	Each unit < 180W	7.8kg
	DY25	4.2-4340				
CF600 IV CF600PlusIV	YZ35 YZ35-PPS	6.9-12000	Servo motor	310×228×248mm	Each unit < 300W	11.9kg



Integrated Filling System

DF600



Features

- Integrated design, one controller can control 4 groups (total 16) filling units.
- It can support the production filling line, store 60 commonly used filling modes.
- Each filling unit can independently receive stop filling signal when bottle absent.

Model Number

- DF600, DF600II, DF600 Plus, DF600 PlusII

Typical Application

- Pharmaceutical, health product filling, diagnostic reagent dispensing.
- Food, beverage filling.
- Cosmetic filling.

DF600 Plus



Features

- Connected with HMI, PLC etc, industrial control system, one controller can control 8 groups (total 32) filling units. It can display the details of 16 filling units in the HMI, widely used in industrial control application.



Dispensing volume interface



Dispensing time and pause time interface



Copy numbers interface



Integrated Filling System

DF600IV(servo motor control)



DF350(servo motor control)



Product Introduction

DF servo control series is integrated type intelligent filling system with high precision and low pulsation driven by servo motor. It is composed by control unit and integrated type filling units, each group have 4 filling units, total 16 filling units. This system use imported 4.3" industrial grade true color display with touch screen control, can preset filling volume, filling time, pause time, copy numbers and back-suction angle. Dynamics display working status, filling data, setting parameter, system configuration display at the same screen; with intelligent calibration and online micro adjust function. Can connect foot pedal and receive switch signal, realize long-distance control. With motor working status output signal, can let other equipment realtime monitor the current filling status of peristaltic pump. This filling system use servo motor, and high precision, low pulsation pump head to make the filling precision higher, up to 0.1%-0.6%, make the micro volume and big volume high precision filling come true.

Model Number

- | DF350
- | DF350 Plus
- | DF600III
- | DF600 PlusIII
- | DF600IV
- | DF600 PlusIV

Typical Application

- | Pharmaceutical, health product filling, diagnostic reagent dispensing.
- | Food, beverage filling.
- | Cosmetic filling.



Integrated Filling System

Dimension Drawing(Unit: mm)

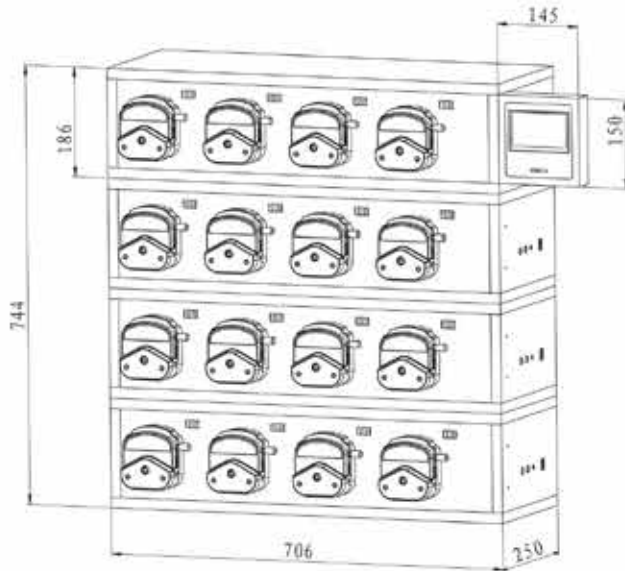

DF600 Dimension

External Control Schematic Diagram

DF600 has filling status output signal, can be monitored by other equipments.

DF600 plus adopt standard MODBUS communication protocol, can be well connected with HMI to achieve logic control.

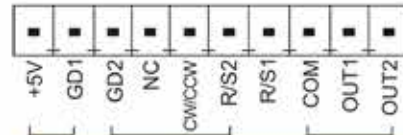

DF600 External Control Schematic Diagram

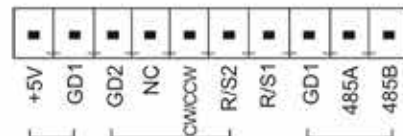

DF600plus External Control Schematic Diagram

The pump type suffixed with "Plus" support MODBUS communication protocol

Drive	Pump Head	Flow Rate (mL/min)	Motor Type	Drive Dimension (L×W×H)	Power Consumption	Drive Weight
DF600 DF600Plus	YZ1515x YZ2515x	0.07~2280 1.7~1740	Stepper motor	706×250×186mm	Each Unit < 50W	21.8kg
DF600 II DF600Plus II	DZ25-3L	2.11-3600	Servo motor	706×250×186mm	Each Unit < 80W	21.8kg
DF600 III DF600Plus III	DZ25-6L	3.0-6000	Servo motor	910×290×212mm	Each Unit < 180W	41.45kg
DF350 DF350Plus	DY15 DY25	0.1-3337 4.2-4340	Servo motor	910×290×212mm	Each Unit < 180W	41.45kg
DF600IV DF600Plus IV	YZ35 YZ35-PPS	6.9-12000	Servo motor	1056×310×248m	Each Unit < 300W	58.6kg



Pharmaceutical Filling Machine

Cosmetic Filling Line



Technical Specifications

Speed range	CF350/DF350	1-350 rpm	Display	4.3" industrial grade true color LCD screen
	CF350 Plus/DF350 Plus	1-350 rpm	Control method	Touch screen and mechanical keypad
	CF600III/DF600III/DF600IV	1-600 rpm	Keypad lifetime	300,000 times
	CF600 PlusIII/DF600 PlusIII/DF600 PlusIV	1-600 rpm	Start/stop, direction signal	Passive switch signal, such as foot pedal switch Active switch signal: 5V, 12V, 24V for option
Filling volume range	0.1-9999.99 mL		Output interface	Output motor working status (Open-Collector output)
Filling time range	0.5-9999.99 s/	DF600 Plus		
Pause time range	0.5-9999.99 s/	DF600 Plus	0.1-9999.99 s	Power supply
Filling volume resolution	0.01 mL		AC 220V±10% 50Hz/60Hz (standard) AC 110V±10% 50Hz/60Hz (optional)	
Time resolution	0.01 s			Condition temperature
Copy numbers	1-9999,'0' means unlimited		Relative humidity	
Back suction angle	0-360°			IP rate
Filling accuracy	<±0.5%			

Product Composition and Flow Rate Range

Drive	Pump Head	Pump Head Material	Tube Clamp Material	Tubing		(Motor Speed 1~600rpm) Flow Rate mL/min	
				Tubing size	ID×Wall Thickness		
DF600 CF600 DF600 Plus CF600 Plus	YZ1515x	PSF PPS	————	13"	0.8×1.6 (mm)	0.07~42	
				14"	1.6×1.6 (mm)	0.27~162	
				19"	2.4×1.6 (mm)	0.55~330	
				16"	3.1×1.6 (mm)	0.82~492	
				25"	4.8×1.6 (mm)	1.7~1020	
				17"	6.4×1.6 (mm)	2.9~1740	
				18"	7.9×1.6 (mm)	3.8~2280	
	DF600II CF600II DF600 PlusII CF600PlusII	DZ25~3L	Aluminum alloy/PPS	PP	15"	4.8×2.4 (mm)	1.7~1020
					24"	6.4×2.4 (mm)	2.9~1740
					15"	4.8×2.4 (mm)	2.11~1264
DF600III CF600III DF600 PlusIII CF600 PlusIII	DZ25~6L	Aluminum alloy/PPS	PP	24"	6.4×2.4 (mm)	3.85~2310	
				35"	7.9×2.4 (mm)	5.08~3050	
				36"	9.6×2.4 (mm)	6~3600	
				15"	4.8×2.4 (mm)	3~1800	
DF600IV CF600IV DF600 PlusIV CF600 PlusIV	YZ35~PPS	PPS	PP	24"	6.4×2.4 (mm)	5.5~3300	
				35"	7.9×2.4 (mm)	8~4800	
				36"	9.6×2.4 (mm)	10~6000	
				26"	6.4×3.3 (mm)	6.9~4200	
				73"	9.6×3.3 (mm)	12.3~7400	
				82"	12.7×3.3 (mm)	20~12000	
Drive	Pump Head	Pump Head Material	Tube Clamp Material	Tubing		(Motor Speed 1~350rpm) Flow Rate mL/min	
				Tubing	ID×Wall Thickness		
DF350 CF350 DF350 Plus CF350 Plus	DY15	Aluminum alloy	PP	13"	0.8×1.6 (mm)	0.1~48	
				14"	1.6×1.6 (mm)	0.6~223	
				19"	2.4×1.6 (mm)	1.3~448	
				16"	3.1×1.6 (mm)	2~723	
				25"	4.8×1.6 (mm)	4.7~1626	
				17"	6.4×1.6 (mm)	6.4~2230	
				18"	7.9×1.6 (mm)	9.5~3337	
	DY25	Aluminum alloy	PP	15"	4.8×2.4 (mm)	4.2~1480	
				24"	6.4×2.4 (mm)	7.6~2670	
				35"	7.9×2.4 (mm)	10~3600	
36"				9.6×2.4 (mm)	12.4~4340		



Filling Volume Reference (Media is water)

Drive	Pump Head	Tubing	Filling Volume (mL)	Filling Time (s)	Accuracy (±%)	Output (pcs/min)	Motor Speed (rpm)	
DF600 CF600 DF600 Plus CF600 Plus	YZ1515x YZ2515x	13"	0.1	0.5	± 5ul	40	204.083	
		13"	0.3	0.7	1.5	35	426.251	
		13"	0.5	1	0.8	30	516.081	
		13"	1	2	0.5	20	517.152	
		14"	2	1	1	30	446.724	
		14"	3	1.5	0.8	24	446.479	
		19"	5	1.2	1	27	454.919	
		16"	7	1	0.5	30	457.705	
		25"/15"	10	1	1	30	303.426	
		25"/15"	15	1	0.8	30	461.273	
		25"/15"	20	1.2	0.5	27	518.945	
		17"/24"	30	1.2	0.8	27	462.725	
		17"/24"	50	2	0.5	20	461.595	
		18"	80	2.5	0.5	17	427.274	
DF600 II CF600 II DF600 Plus II CF600Plus II	DZ25-3L	15"	16	1	0.5	30	454.976	
		24"	30	1.2	0.5	27	389.610	
		35"	150	4	0.5	12	442.913	
		36"	200	4	0.5	12	500.000	
DF350 CF350 DF350 Plus CF350 Plus	DY15	14"	0.5	0.5	0.3	60	94.1915	
		14"	1	1	0.4	30	94.1915	
		14"	2	1	0.6	30	188.383	
		19"	3	1	0.3	30	140.625	
		16"	5	1	0.5	30	145.278	
		25"	10	1	0.3	30	129.143	
		25"	15	1	0.4	30	193.715	
		17"	30	1	0.4	30	282.530	
	18"	100	2.5	0.3	17	251.730		
	DY25	15"	10	1	0.3	30	141.911	
		24"	30	1	0.5	30	235.972	
		35"	70	1.2	0.4	27	340.466	
		36"	100	2	0.2	20	241.935	
		DF600 III CF600 III DF600 Plus III CF600 Plus III	DZ25-6L	15"	80	4	0.4	12
24"				150	4	0.4	12	409.090
35"	200			3.2	0.5	14	468.750	
36"	300			3.5	0.5	13	514.285	
DF600IV CF600IV DF600 PlusIV CF600 PlusIV	YZ35-PPS	26"	150	3	0.5	15	428.570	
		73"	300	3	0.5	15	486.499	
		82"	500	3	0.5	15	500.000	



Standard Peristaltic Pump

LabM1, LabM3, LabM6

3 years warranty



Model Number

LabM1, LabM3, LabM6

Typical Application

University laboratory.
Supporting ion chromatography and titrator.

Suitable Pump Head



YZ1515x



YZ2515x



MC Series



DG Series

Features

- 3 digital LED display motor speed, mechanical keypad control.
- Timing function, the time range of 0.5 seconds -999 seconds can be used as a simple dispensing
- Support RS232 and RS485 communication, Modbus protocol.

Technical Specifications

Flow rate range	LabM1: 0.000829~570 mL/min LabM3: 0.000829~1330 mL/min LabM6: 0.000829~2280 mL/min	Start/stop, direction signal	Passive switch signal, such as foot pedal switch; Active switch signal: 24V default
Speed resolution	0.1rpm when the speed is 0-100rpm, 1rpm when the speed is 100-600rpm.	Communication interface	RS485(optional),Modbus protocol(RTU mode) RS232(standard), Shenzhen communication protocol;
Testing time range	0.5s-999s	Power supply	AC 220V±10%, 50Hz/60Hz (standard) AC 110V±10%, 50Hz/60Hz (optional)
Outlet pressure	0.1Mpa (0.8-1.0mm wall thickness tubing) 0.1-0.27Mpa (1.6-2.4mm wall thickness tubing)	Drive dimension	261.4×157.3×236.9mm (L×W×H)
Display	3 digital LED	Drive weight	4.40 kg
Control method	Mechanical keypad	Power consumption	< 50W
Keypad lifetime	300,000 times	Condition temperature	0-40°C
External speed control signal	0-5V(standard), 4-20mA, 0-10V (optional)	Relative humidity	< 80%
		IP rate	IP31

Product Composition and Flow Rate Range

Basic Peristaltic Pump	Pump Head & Flow Rate (mL/min)			
	YZ1515x	YZ2515x	MC1-MC12(10)	MC1-MC12(6)
Drive & speed	Tubing		Inner diameter: 0.13-3.17mm Wall thickness: 0.8-1mm	
	13", 14", 19", 16" 25", 17", 18"	15", 24"		
LabM1	0.5-150rpm	0.035~570	0.85~435	
LabM3	0.5-350rpm	0.035~1330	0.85~1015	0.000829~49(suggestion working speed≤150rpm)
LabM6	0.5-600rpm	0.035~2280	0.85~1740	0.000925~65(suggestion working speed≤150rpm)



Standard Peristaltic Pump



Features

- Servo motor drive, powerful and maintenance-free.
- 3 digital LED display motor speed, rotary encoded switch control.
- Suitable for industrial sites, transfer liquid with large flow and high precision.

Model Number

- N6-3L/DZ25-3L
- N6-6L/DZ25-6L
- N6-12L/YZ35

Technical Specifications

Flow rate range	N6-3L: 0.211~3600 mL/min N6-6L: 0.3~6000 mL/min N6-12L: 0.00069~12 L/min	Start/stop, direction signal	Passive switch signal, such as foot pedal Active switch signal: 24V default
Speed range	0.1-600 rpm	Communication interface	RS232(standard), Shenchen-N232 Communication protocol, RS485(optional), Modbus protocol(RTU mode)
Speed resolution	0-100rpm, 0.1rpm; 100-600rpm, 1rpm.	Power supply	AC 220V±10% 50Hz/60Hz (standard) AC 110V±10% 50Hz/60Hz (optional)
Flow rate accuracy	<±0.5%	Drive dimension (L×W×H)	N6-3L: 223×152×168mm N6-6L: 283×192×218mm N6-12L: 302×222×275mm
Outlet pressure	0.3Mpa	Drive weight	N6-3L: 5.02kg; N6-6L: 7.85kg N6-12L: 13.14kg
Motor type	Servo motor	Power consumption	N6-3L: < 80W; N6-6L: < 180W N6-12L: < 300W
Display	3 digital LED	Condition temperature	0-40°C
Control method	Mechanical keypad	Relative humidity	< 80%
Keypad lifetime	300,000 times	IP rate	IP31
Speed control	Rotary encoded switch		
External speed control signal	0-5V(standard), 0-10V, 4-20mA(optional)		

Product Composition and Flow Rate Range

Drive	Motor Type	Pump Head	Tubing Size	Speed Range(rpm)	Flow Rate(mL/min)
N6-3L	Stepper motor/Servo Motor	DZ25-3L	15', 24', 35', 36'	0.1-600	0.211~3600
N6-6L	Servo Motor	DZ25-6L	15', 24', 35', 36'		0.3~6000
N6-12L		YZ35	26', 73', 82'		0.69~12000



Basic Peristaltic Pump

BT100N, BT300N, BT600N

3 years warranty



Model Number | BT100N, BT300N, BT600N



Features

- Plastic coated metal housing, compact structure.
- Timing function, time range 0.5s-999s, can be used for simple dispense.
- RS232, RS485 Communication Interface.
- Support Shenchen communication protocol or standard Modbus communication protocol(RTU mode).

Technical Specifications

Flow rate range	BT100N: 0.000829-570 mL/min BT300N: 0.000829-1330 mL/min BT600N: 0.000829-2280 mL/min	Start/stop, reversing signal	Passive switch signal, such as foot pedal Active switch signal: 5V,12V,24V for option
Speed resolution	0-100rpm, 0.1rpm; 100-600rpm, 1rpm	Communication interface	RS232(standard),Shenchen-N232 Communication protocol; RS485(optional), Modbus protocol(RTU mode)
Testing time range	0.5 s-999 s	Power supply	AC 220V±10% 50Hz/60Hz (standard) AC 110V±10% 50Hz/60Hz (optional)
Outlet pressure	0.8-1.0 mm wall thickness tubing: 0.1Mpa; 1.6-2.4mm wall thickness tubing:0.1-0.27Mpa	Drive dimension	183×131×194mm
Display	LED Display	Drive weight	4.20 kg
Control method	Mechanical keypad	Power consumption	< 50W
Keypad lifetime	300,000 times	Condition temperature	0-40°C
External speed control signal	0-5V(standard), 0-10V, 4-20mA(optional)	IP rate	IP31
Relative humidity	< 80%		

Product Composition and Flow Rate Range

Standard Peristaltic Pump	Tubing	Pump Head & Flow Rate (mL/min)			
		YZ1515x	YZ2515x	MC1-MC12(10)	MC1-MC12(6)
Drive & speed		13', 14', 19', 16', 25', 17', 18'	15', 24'	Inner diameter: 0.13-3.17mm Wall thickness: 0.8-1mm	
BT100N	0.5-150rpm	0.035-570	0.85-435	0.000829-49(suggestion working speed ≤ 150rpm)	0.000925-65(suggestion working speed ≤ 150rpm)
BT300N	0.5-350rpm	0.035-1330	0.85-1015		
BT600N	0.5-600rpm	0.035-2280	0.85-1740		



Basic Peristaltic Pump

BT100M, BT300M, BT600M

3 years warranty



Features

- 3 digital LED display motor speed.
- Toggle switch control start/stop and direction.
- Rotary encoded switch control speed, easy operation.
- Economical and durable, suitable for different industrial application.

Model Number

- BT100M, BT300M, BT600M

Typical Application

- Add cement grinding aids
- Support industrial production line

Technical Specifications

Flow rate range	BT100M: 0.00166~570 mL/min BT300M: 0.00166~1330 mL/min BT600M: 0.00166~2280 mL/min	Start/stop, direction signal	TTL level signal
Speed resolution	0.1rpm when the speed is 0-100rpm, 1rpm when the speed is 100-600rpm.	Communication interface	RS485(optional), Modbus protocol(RTU mode)
Outlet pressure	0.1Mpa (0.8-1.0mm wall thickness tubing) 0.1-0.27Mpa (1.6-2.4mm wall thickness tubing)	Power supply	AC 110V±10%, 50Hz/60Hz (optional)
Back suction angle	0-360°(optional)	Drive dimension (L×W×H)	BT100M: 234×144×140mm BT300M, BT600M: 254×185×149mm
Display	3 digital LED	Drive weight	BT100M: 3.6kg BT300M, BT600M: 4.64kg
Control method	Toggle switch+Rotary encoded switch	Power consumption	< 50W
Keypad lifetime	300,000 times	Condition temperature	0-40°C
External speed control signal	0-5V(standard), 0-10V, 4-20mA(optional)	Relative humidity	< 80%
		IP rate	IP31

Product Composition and Flow Rate Range

Basic Peristaltic Pump	Pump Head & Flow Rate (mL/min)			
	YZ1515x	YZ2515x	MC1-MC12(10)	MC1-MC12(6)
Drive & speed	13', 14', 19', 16'	15', 24'	Inner diameter: 0.13-3.17mm Wall thickness: 0.8-1mm	
Tubing	25', 17', 18'			
BT100M	1-150rpm	0.07~570	1.7~435	0.00166~49(suggestion working speed ≤ 150rpm)
BT300M	1-350rpm	0.07~1330	1.7~1015	0.00185~65(suggestion working speed ≤ 150rpm)
BT600M	1-600rpm	0.07~2280	1.7~1740	



Basic Peristaltic Pump

ZG600x



Product Introduction

Industrial peristaltic pump type, flow rate: 414-12000 mL/min. Use high power DC motor drive, strong power, can drive two pump heads. Suitable for large flow rate or high pressure application, such as industry production and filtration system.

Typical Application

- | Adding chemicals to mineral processing system.
- | Support molecular tangential flow ultrafiltration equipment.
- | Adding acid base into industrial fermentation system.

Dimension Drawing (Unit: mm)

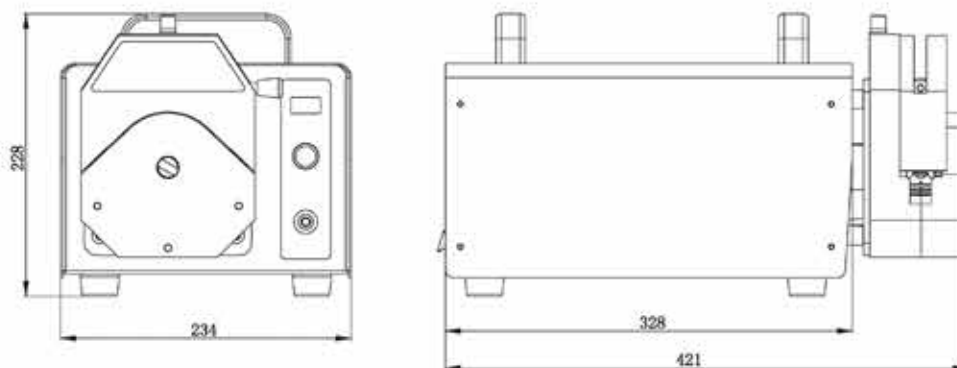

Technical Specifications

Flow rate range	414-12000 mL/min	External speed control signal	0-5V,0-10V,4-20mA for option
Speed range	60-600 rpm	Power supply	AC 220V±10% 50Hz/60Hz (standard)
Rotation direction	reversible		AC 110V±10% 50Hz/60Hz (optional)
Speed resolution	1 rpm	Drive dimension	328×234×228mm(L×W×H)
Flow rate accuracy	< ± 0.5%	Drive weight	17kg
Outlet pressure	0.3Mpa	Power consumption	< 300W
Motor type	DC motor	Condition temperature	0-40°
Display	4 bit LED shows the current speed	Relative humidity	< 80%
Speed control	Multiturn potentiometer control motor speed	IP rate	IP31

Product Composition and Flow Rate Range

Drive	Pump Head	Tubing Size	Speed range(rpm)	Flow Rate(mL/min)
ZG600x	YZ35,YZ35-PPS	26', 73', 82'	60-600	414~12000
	2·YZ35,2·YZ35-PPS	26', 73', 82'		(each channel) 414~12000



Planetary gear type industrial peristaltic pump

J25

Product Introduction

J25 peristaltic pump head use aluminum alloy shell, 304 stainless steel rollers, long lifetime, corrosion resistance; big flow rate, high pressure, suitable for transfer high viscosity and high lift liquid; Driven by AC motor, can use frequency adapter to adjust speed and flow rate, can also connect with PLC, IPC and computers.

Typical Application

- | Bio-medical
- | Chemical industry
- | Environmental protection

Roller Components Graph



Dimension Drawing (Unit: mm)

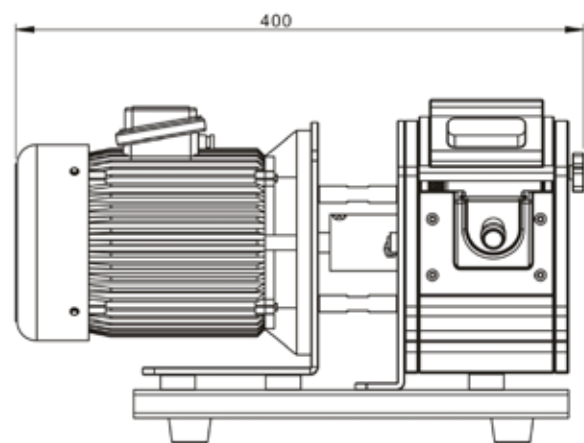
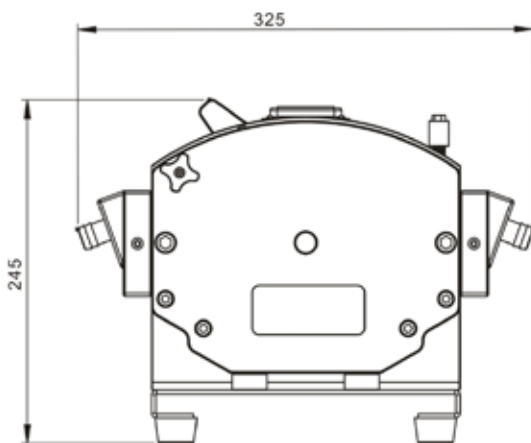

Product Composition and Flow Rate Range

Pump Head	Power Supply	Power	Speed (rpm)	Tubing		Flow Rate (L/min)	Pressure (Mpa)		Weight
				Size	ID*Wall thickness (mm)		Continuous	Intermittent	
DZ45	AC380V/50Hz	370W	37.5-350	88#	12.7*4.8	1.0-14.3	0.25	0.3	30kg
			37.5-270	92#	25.4*4.8	3.68-28.15			

Explosion Proof Peristaltic Pump

EXP600/YZ35



Features

Driven by explosion-proof motor, the power is strong.
Stepless speed regulation, reversible inversion.

IP rate: IP55
Explosion-proof grade: ExdIIBT4 Gb

Suitable for inflammable and explosive industrial sites.

Dimension Drawing (Unit: mm)

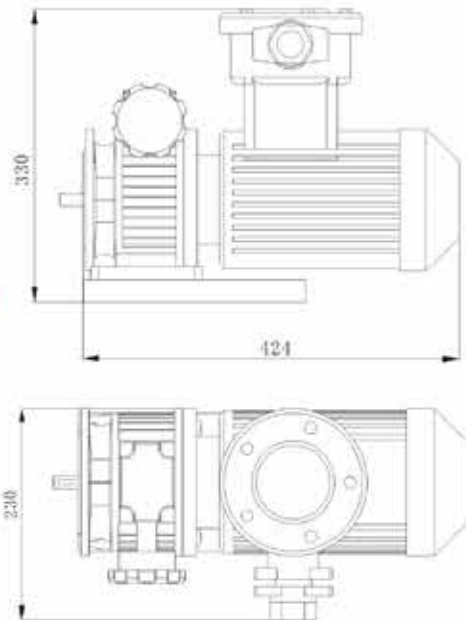

Explosion Proof Peristaltic Pump

Stainless steel housing

Frequency converter



Technical Specifications

Speed range	180-600 rpm	Drive weight	30 kg
Speed control	Manual stepless speed regulation	Condition temperature	0~40°C
Voltage	AC 3 phase 380V	Relative humidity	<80%
Drive dimension (LxWxH)	424x230x330 (mm)	Explosion-proof grade	ExdIIBT4 Gb
		IP rate	IP55

Product Composition and Flow Rate Range

Drive	Speed	Pump Head	Tubing Size	Flow Rate (mL/min)
EXP600	180-600rpm	YZ1515x	13', 14', 19', 16', 25', 17', 18'	12.6~2280
		YZ2515x	15', 24'	306~1740
		YZ35	26', 73', 82'	1242~12000
		DZ25-3L	15', 24', 35', 36'	379.8~3600
		DZ25-6L	15', 24', 35', 36'	540~6000
		SN15	14', 16'	43.2~528
		SN25	24'	450~1500



Explosion Proof Peristaltic Pump

Suitable Pump Head

QD600



YZ1515x



YZ2515x



DZ25-3L



SN Series

Features

Pneumatic motor driver, gas driving, explosion-proof and safe.

Stepless speed regulation, manual control flow valve. Start/stop, direction, overload protection functions.

Barometer, convenient for users to check the pressure value.

Suitable for inflammable, explosive industrial sites.

Dimension Drawing (Unit: mm)

Working status dimension drawing (Unit: mm)

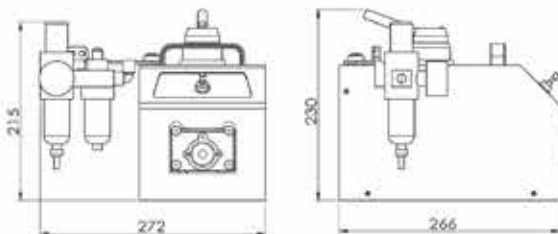

Non-working status dimension drawing (Unit: mm)

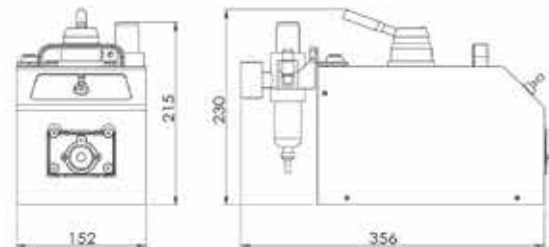

Technical Specifications

Speed range	60~600 rpm	Drive dimension (L x W x H)	Working: 266x 272 x 230mm Non-working: 356x 152 x 230mm
Display	Display air pressure	Drive weight	4.10 kg
Speed control	stepless speed regulation (By adjusting the flow valve)	Power consumption	< 80W
Control function	Start/stop, reversing (gas reversing valve control)	Condition temperature	0-40°C
Working air pressure	0.1-0.4Mpa	Relative humidity	< 80%
Gas consumption	4L/Sec	IP rate	IP31

Product Composition and Flow Rate Range

Peristaltic Pump		Pump Head & Flow Rate (mL/min)			
		YZ1515x	YZ2515x	MC1-MC12(10)	DZ25-3L
Drive & Speed	Tubing	13', 14', 19', 16' 25', 17', 18'	15', 24'	Inner diameter: 0.13-3.17mm Wall thickness: 0.8-1mm	15', 24', 35', 36'
	QD600	60-600rpm	5-2280	100-1740	0.111-65(suggestion working speed ≤ 150rpm)



Hand Sampling Pump

SC600



Product Maintenance

- When the pump is not working, please release the pump head upper block, to avoid the tubing deformation because of long-time extrusion.
- Please keep the pump head roller clean and dry, or it will faster the tubing wear, shorten the tubing lifetime, and damage the rollers.
- Pump head can not resist strong corrosive liquid, please pay attention to this.

Sampling Nozzle



Product Introduction

Hand sampling pump usually used for emergency monitoring and temporary water sampling, can be used as stratified water sampler, portable water sampler and deep water sampler.

Product Features

- Rechargeable power supply, portable and suitable for non-electrical place.
- Use easy load pump head, simple application and easy to clean. Imported portable drive, speed is adjustable.
- Speed 1 is 0-350rpm, speed 2 is 0-1200rpm, stepless speed regulation, direction is reversible.
- Can collect high proportion and high viscosity liquid, can collect liquid which include solid, also can stratified sampling. Suction lift can reach 8 meters.
- Standard: Drive, charger, battery, pump head and sampling nozzle.

Dimension Drawing (Unit: mm)

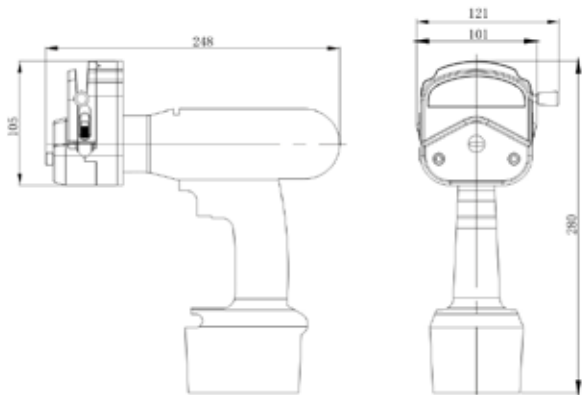

Technical Specifications

Speed range	Speed 1: 0-350rpm Speed 2: 0-1200 rpm	Power supply	Charging power supply AC220V 50/60Hz (AC110V 50/60Hz Option)
Dimension	243mm × 120mm × 280mm (L×W×H)	Suction lift	8m
Drive weight	2.1kg	IP rate	IP31
Working condition	Outdoor, indoor		

Product Composition and Flow Rate Range

Drive	Pump Head	Tubing Size	Flow Rates(mL/min)
SC600	YZ1515x	13", 14", 19", 16", 25", 17", 18"	0-2280
	YZ2515x	15", 24"	0-1740
	DZ25-3L	15", 24", 35", 36"	0-3600



Compact Pump Head

MicroPump



Model No

MicroPump, Flow Rate: 0.004-149.23mL/min

Product Features

Beautiful appearance, compact size, variety colors to choose, OEM ideal choice, can be driven by stepper motor, DC motor etc.

Industry Application

- | Biochemical analyzer, support medical equipment
- | Plant protection drone

Pump Head Installation Procedure

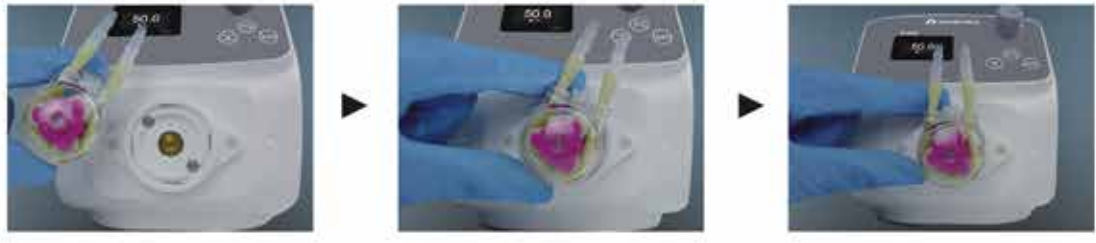

35 Stepper motor

Dimension Drawing(Unit: mm)

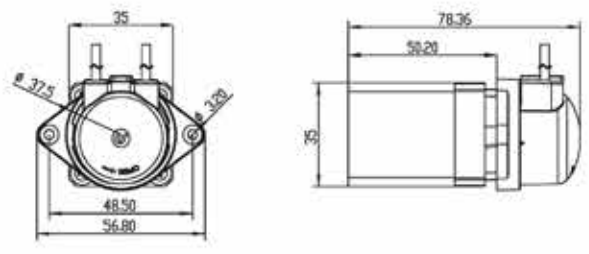

DC motor

Dimension Drawing(Unit: mm)

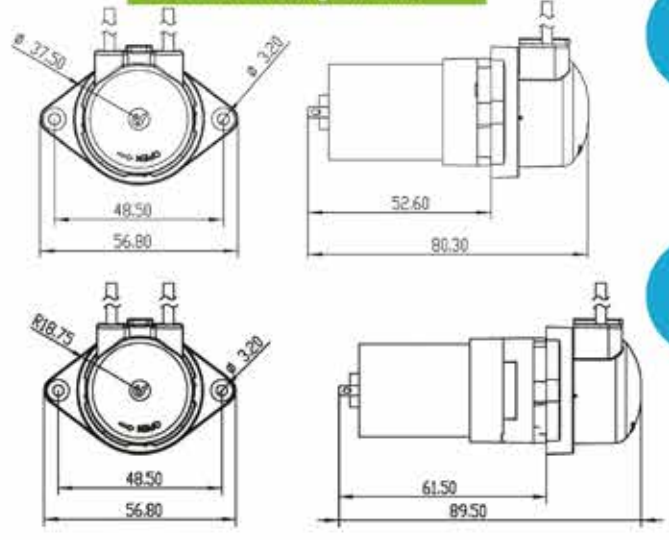

Single gear

Double gear



Compact Pump Head

Stepper motor breakdown drawing

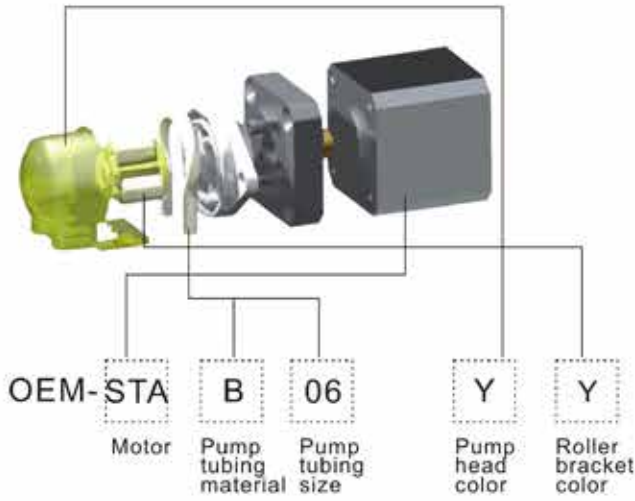

DC motor breakdown drawing

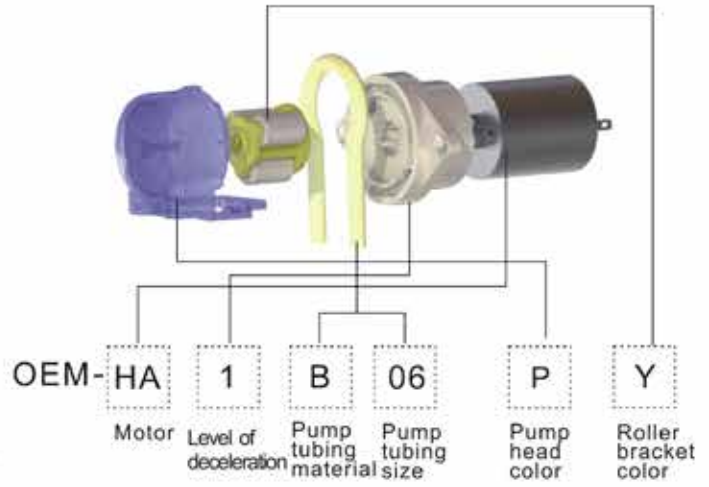

Color Selection



Pump head housing and roller bracket color

	Transparency	Green	Red	Yellow	Purple
Pump head color	T	G	R	Y	P
Roller bracket color	White	Green	Red	Yellow	Blue
	W	G	R	Y	B

Flow model selection

Tubing No.			S04	S06	S10	S22	B04	B06	B10	B22	
Tubing ID. (wall thickness 1mm)			1mm	2mm	3mm	4mm	1mm	2mm	3mm	4mm	
Tubing material			Silicone tubing	Silicone tubing	Silicone tubing	Silicone tubing	BPT	BPT	BPT	BPT	
Flow rate (mL/min)	24V Brush/Brushless HA/HD	Single gear	14.88	50.05	110.27	149.23	14.88	50.05	110.27	149.23	
		Double gear	1.28	4.29	9.45	12.79	1.28	4.29	9.45	12.79	
	12V Brush/Brushless HB/HE	Single gear	14.88	50.05	110.27	149.23	14.88	50.05	110.27	149.23	
		Double gear	1.28	4.29	9.45	12.79	1.28	4.29	9.45	12.79	
	6V Brush/Brushless HC/HF	Single gear	14.88	50.05	110.27	149.23	14.88	50.05	110.27	149.23	
		Double gear	1.28	4.29	9.45	12.79	1.28	4.29	9.45	12.79	
	35 Stepper motor(150rpm)STA			6.42	21.5	47.26	63.95	6.42	21.5	47.26	63.95
	35 Stepper motor(350rpm)STB			14.88	50.05	110.27	149.23	14.88	50.05	110.27	149.23



Compact Pump Head

MiniPump Series

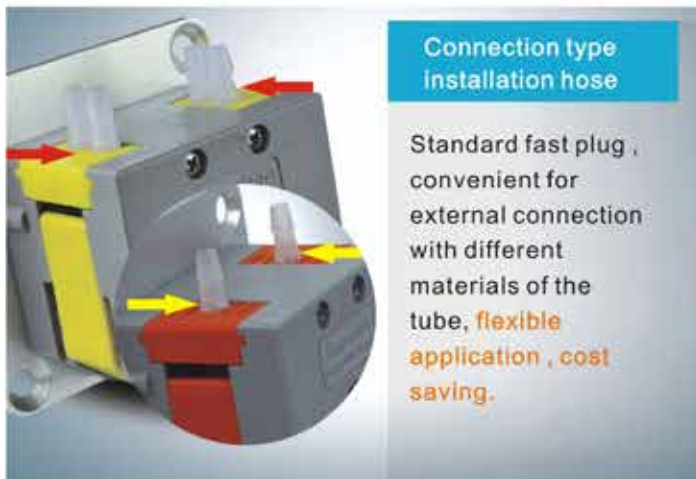

Connection type Installation hose

Standard fast plug , convenient for external connection with different materials of the tube, **flexible application , cost saving.**

Product Introduction

Minipump series products which adopt compact and embedded design are more suitable for supporting a variety of instruments and equipments. Single and dual channel are optional. It accepts 8 kinds of tubing. Flow rates are 0.0024-190 mL/min. PharMed BPT long-life tubing from French Saint-Gobain is installed in internal part of pump head. Applicable motors for Minipump are stepper motor, DC motor, AC motor and other modes to drive with wide applications.



Soft tube connect to hard tube

Supporting conversion connector (soft tube transfer hard tube), connect directly with a variety of hard tubes.



Install hose without connector

1. Adopt special hygienic grade tube. The whole tube is installed.
2. No connection simplifies design to **prevent leakage and pollution risk**

Features

- | Attractive appearance, compact structure.
- | Easy to operate and economical cost.
- | Accept many kinds of motors to drive.
- | Supply several colors of appearance, ideal for supporting analytical instruments.

Typical Application

- | Discharge condensate water in the flue gases survey meter.
- | Support biochemistry analytical instruments.

Tubing Installation Procedure

A. Make the two tubing clamps align the slide way of pump head two sides.



B. Ensure that the tubing is in the middle of rollers, and push the clamps into the pump head.



C. Make the compression block align the upper slide way of pump head.



D. Press the compression block into the pump head, and ensure it fixed.



OEM-B01



Dimension Drawing(Unit: mm)

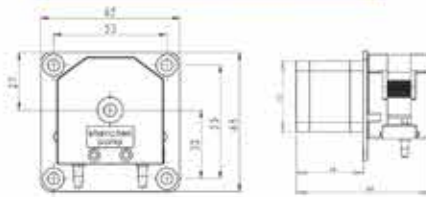

Speed range	≤300 rpm
Max flow rate	190mL/min
Motor type	42 stepper motor
Motor phase number	2
Motor step angle	1.8
Motor phase voltage	2.2V
Motor phase current	1.0A

OEM-B02, OEM-B03, OEM-B04



Dimension Drawing(Unit: mm)

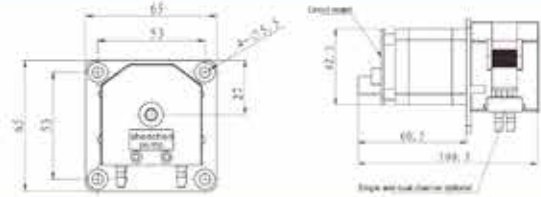

OEM-B02 Technical Specifications		OEM-B022 Technical Specifications		OEM-B03 Technical Specifications	
Speed range	0.1–300 rpm	Speed range	0.1–300 rpm	Speed range	0.1–300 rpm
Flow rate range	0.0024–190mL/min	Flow rate range	0.0024–190mL/min	Flow rate range	0.0024–190mL/min
Speed control	Preset speed or serial port control	Speed control	Adjust speed by internal potentiometer	Speed control	External input pulse frequency speed control
Subdivision settings	1/16	Subdivision settings	1/16	Multiple segments	1/16(recommend), 1, 1/2, 1/4, 1/8, 1/32, 1/64, 1/128
Motor type	42 stepper motor	Motor type	42 stepper motor	Motor type	42 stepper motor
Input voltage	DC 24V	Input voltage	DC 24V	Input voltage	DC 24V
Power	<24W	Power	<24W	Power	<24W

OEM-B013, OEM-B014



Dimension Drawing(Unit: mm)

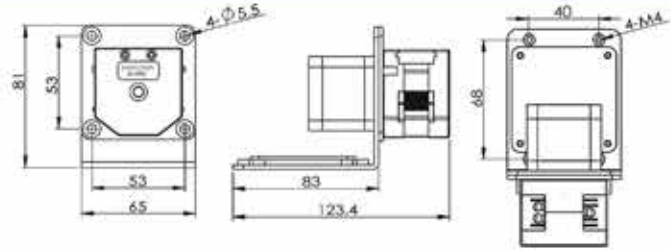

OEM-B013 Technical Specifications		OEM-B014 Technical Specifications	
Speed range	0.1–300rpm	Speed range	0.1–300rpm
Flow rate range	0.0024–190ml/min	Flow rate range	0.12–190ml/min
Communication interface	RS232,RS485 interface modbus protocol, control start/stop, direction and speed	Speed control	Potentiometer speed regulation
Address setting	1–32	External analog signal control	0–5V, 0–10V, 4–20mA 3 analog signal for option
Motor type	42 stepper motor	External control	Start/stop, direction (external passive signal control)
Input voltage	DC 24V	Motor type	42 stepper motor
Power	<30W	Input voltage	DC 24V
		Power	<30W

OEM-B136, OEM-B137

Dimension Drawing(Unit: mm)



Pump Head NO.	L
2	75.6
3	113.4
4	151.2

OEM-B136 Technical Specifications		OEM-B137 Technical Specifications	
Speed range	0.1–300 rpm	Speed range	0.1–300 rpm
Flow rate range	0.0024–190mL/min	Flow rate range	0.0024–190mL/min
Speed control	Preset speed and manual control	Speed control	Pulse frequency speed control
Control mode	External passive signal level (normally closed or open) mode; control the start/stop of direction	Logic input voltage	5V, 12V, 24V(default 5V)
Display(optional)	0.96" OLED screen	Multiple segments	1/16(recommend), 1, 1/2, 1/4, 1/8, 1/32, 1/64, 1/128
Motor type	57 stepper motor	Motor type	57 stepper motor
Input voltage	DC 24V	Input voltage	DC 24V
Power	<60W	Power	<60W



OEM-B039



Dimension Drawing(Unit: mm)

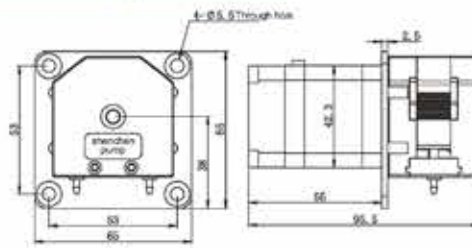

Speed range	0.1-300rpm
Flow rate range	0.0024-190mL/min
Speed control	External input pulse frequency speed control
Multiple segments	1/16(recommend), 1, 1/2, 1/4, 1/8, 1/32
Motor type	42 stepper motor
Input voltage	DC 24V
Power	< 24W

OEM-MZ Serie



Dimension Drawing(Unit: mm)

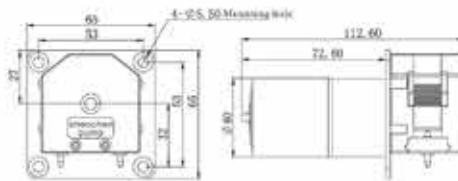

Model No.	Rotation Speed (rpm)	Power Supply	Motor Type
OEM-MZ01	170	DC 12V or DC 24V	Ø 37 DC Motor
OEM-MZ11	5		
OEM-MZ12	10		
OEM-MZ13	15		
OEM-MZ14	20		
OEM-MZ15	30		
OEM-MZ16	50		
OEM-MZ17	100		
OEM-MZ18	160		
OEM-MZ19	167		
OEM-MZ20	278		

OEM-MJ Serie



Dimension Drawing(Unit: mm)

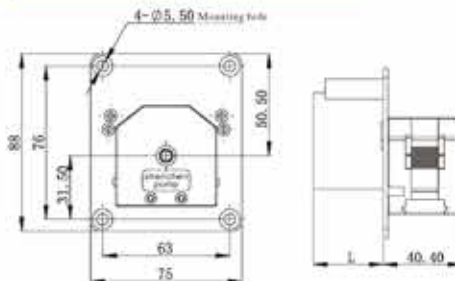

turn direction	L
single direction	18.7
double direction	36

Model No.	Rotation Speed (rpm)	Direction of rotation	Power Supply	Motor Type
OEM-MJ101	2.5/3	Unidirectional	AC 110V or AC 220V	AC Motor
OEM-MJ102	4/5			
OEM-MJ103	5/6			
OEM-MJ201	4.2/5	Bidirectional		
OEM-MJ202	5/6			
OEM-MJ203	11.7/14			

Note: In the rotation of speed, "r" represents the rotation speed in 50/60HZ.

Motor Speed(rpm)	Dual Channel Flow Rate (mL/min) and Tubing (1 mm wall thickness)			
	ID 1mm	ID 2mm	ID 2.5mm	ID 3mm
5	0.25	0.90	1.28	1.78
10	0.49	1.84	2.59	3.52
15	0.74	2.76	3.85	5.30
25	1.25	4.57	6.43	8.80
40	2.00	7.31	10.25	14.02
50	2.52	9.14	12.78	17.47
75	3.76	13.64	19.04	26.12
100	5.03	18.17	25.42	35.34
200	10.12	36.45	51.27	71.44
250	12.63	45.75	64.34	88.35
300	15.01	54.63	76.84	108.39

Motor Speed(rpm)	Single Channel Flow Rate (mL/min) and Tubing (1.6 mm wall thickness)			
	13" ID 0.8mm	14" ID 1.6mm	16" ID 3.1mm	25" ID 4.8mm
5	0.12	0.56	1.97	3.26
10	0.26	1.15	3.90	6.41
15	0.39	1.74	5.80	9.52
25	0.66	2.88	9.59	15.74
40	1.08	4.59	15.29	25.15
50	1.34	5.69	18.96	31.14
75	2.00	8.54	28.36	46.55
100	2.73	11.37	37.66	61.98
200	5.46	22.76	76.02	124.14
250	6.81	28.40	95.08	153.63
300	8.28	33.88	114.31	190.00



Compact Pump Head

UD15

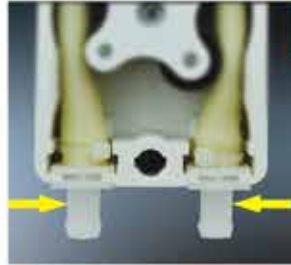

Connection type installation hose

Standard fast plug joint, convenient for external and different materials of the hose, the application of flexibility, cost saving

Dimension Drawing(Unit: mm)

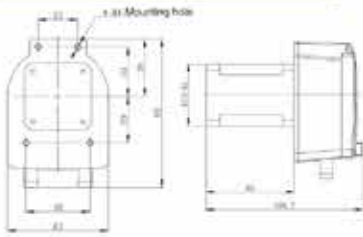

Install hose without connector

1. Adopt special hygienic grade tube, The whole tube is installed.
2. No connection simplifies design to prevent leakage and pollution risk.

Product Introduction

PES material, transparent protecting cover, easily to observe the working situation of pump head and tubing at any time. Various of colors are available. There is water-proof groove in the pump head mounting side. Can use stepper motor, DC motor, AC motor and so on to drive.

Model No.	OEM-UB01
Speed range	≤350rpm
Max. flow rate	930mL
Motor type	42 Stepper motor
Motor phase number	2
Motor step angle	1.8°
Motor phase voltage	3V
Motor phase current	3A

OEM-UB04 OEM-UB05

Dimension Drawing(Unit: mm)

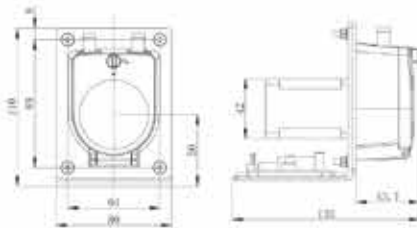

Model No.	OEM-UB04	Model No.	OEM-UB05
Speed range	≤350rpm	Speed range	≤350rpm
Max. flow rate	930mL	Max. flow rate	930mL
Motor type	42 Stepper motor	Motor type	42 Stepper motor
Speed control	Communication control	Speed control	Potentiometer speed control
Communication interface	RS232,RS485 interface modbus protocol, control start/stop, direction and speed.	External analog signal speed control	0-5V,0-10V, 4-20ma for option
Address setting	1-32	Outer control	Passive switch signal control start/stop and direction
Input voltage	DC 24V	Input voltage	DC 24V
Power	<24W	Power	<24W

OEM-UXZ1*

Dimension Drawing(Unit: mm)

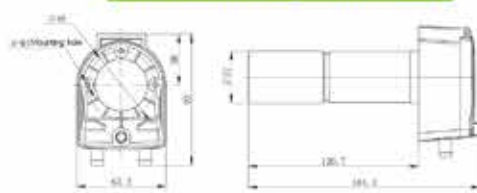

Model No.	Speed (rpm)	Power Supply	Motor Type
OEM-UXZ11	60	DC12V/DC24V	φ 37 DC planetary gear motor
OEM-UXZ12	100		
OEM-UXZ13	150		
OEM-UXZ14	200		
OEM-UXZ15	300		
OEM-UXZ16	350		

OEM-UJ0*

Dimension Drawing(Unit: mm)

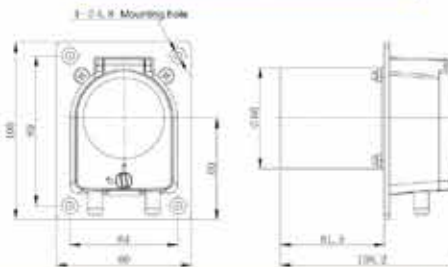

Model No.	Speed (rpm)	Power Supply	Motor Type
OEM-UD15UJ01	2.5	AC110V /AC220V	AC synchronous motor
OEM-UD15UJ02	5		
OEM-UD15UJ03	10		
OEM-UD15UJ04	15		
OEM-UD15UJ05	20		
OEM-UD15UJ06	30		
OEM-UD15UJ07	40		
OEM-UD15UJ08	50		
OEM-UD15UJ09	60		

Model No.	Housing Material		Tubing		Speed Range(rpm)	Flow Rate (mL/min)	Weight (kg)
	Body	Protective cover	Tubing Sizes	ID×Wall Thickness			
UD15	PSF	Transparent PC	16#	3.1×1.6(mm)	0.1~350	0.08~280	0.12
			25#	4.8×1.6(mm)		0.16~580	
			17#	6.4×1.6(mm)		0.26~930	



Compact Pump Head

Product Introduction

UC25, compact pump head, functional design, more practical. Transparent protective cover, can observe the working situation anytime; uncover signal output, stop working when uncover to ensure safety; running smoothly, low noise; support DC motor, brushless DC motor, stepper motor, servo motor and AC motor.

Technical Specifications

Model	Housing Material		Tubing		Speed Range (rpm)	Flow Rate (mL/min)	Weight(kg)
	Base	Protecting cover	Size	ID×Wall(mm)			
UC25	PSF	PC	15 ^ø	4.8×2.4	0.1-600	0.3423~2054	1.39
			24 ^ø	6.4×2.4		0.5033~3020	
			35 ^ø	7.9×2.4		0.8588~5153	
			36 ^ø	9.6×2.4		1.1105~6663	



DC motor Technical Specifications

Model No.	UCX200X series, UCXZ10X series, UCXZ20X series, UCXZ30X series	
Motor type	Brush/Brushless DC planetary gear motor	
Pump head	UC15, UC20, UC25	
Voltage	DC12V/DC24V	
Power consumption	30W	60W
Motor size	φ45mm	φ50mm
Speed(rpm)	5, 10, 20, 80, 100, 120	200, 300
Speed error	≤ ± 10%	
Working temperature	0-40℃	
Relative humidity	< 80%	

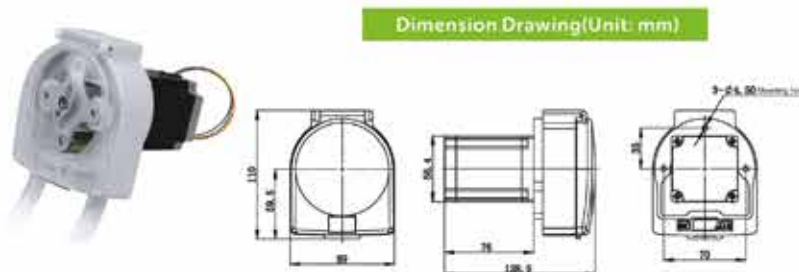

Step motor Technical Specifications

Model No.	OEM-B236	
Motor type	Step motor	
Pump head	UC15, UC20, UC25	
Speed range	≤ 600rpm	
Speed control	Pulse signal	
Subdivision setting	1/16	
Working temperature	0-40℃	
Relative humidity	< 80%	

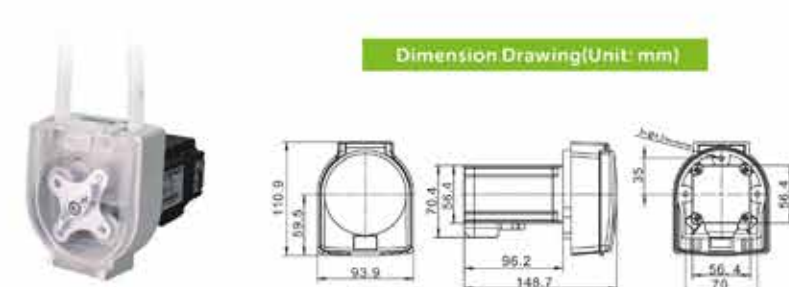

Servo motor Technical Specifications

Model No.	OEM-UCB001	
Motor type	Step servo motor	
Pump head	UC15, UC20, UC25	
Speed range	≤ 600rpm	
Speed control	Pulse signal	
Subdivision setting	1/16	
Power consumption	≤ 80W	
Working temperature	0-40℃	
Relative humidity	< 80%	



Multichannel Pump Head

MD3

Integrated briquettes

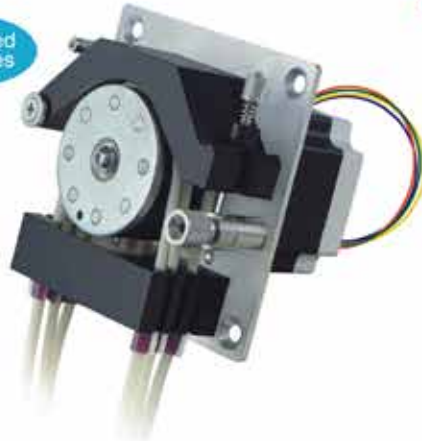

Split briquettes

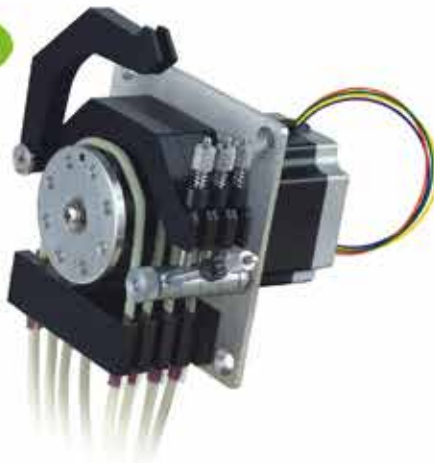

Product Introduction

Suitable for liquid transferring of small flow rate and multiple channels. Complete compression block design, can improve the accuracy among channels effectively; with the function of micro adjustment occlusion, to micro adjust the flow rate and outlet pressure. Eight rollers design, reduce the liquid pulsation; embedded design, very suitable for equipment supporting.

Model Number | MD1, MD2, MD3, MD4

Typical Application | Support analytical instruments

Installation Sizes Drawing (Unit: mm)

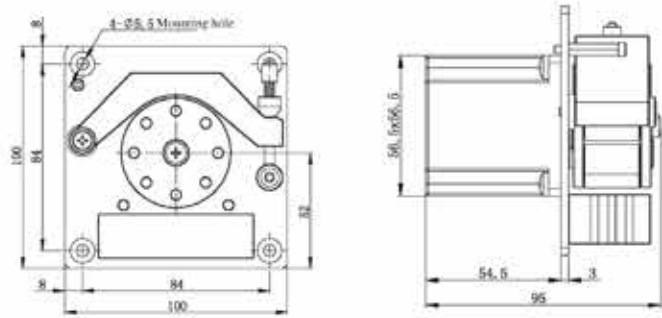

Tubing Installation Procedure



1. Turn the spanner clockwise.



2. Install tubing one by one, from inside to outside.



3. Tubing installation finished.



4. Turn spanner anticlockwise, locking the upper block, micro adjust the occlusion.

Technical Specifications

Pump Head	Channel Number	Speed	Tubing	Flow Rate (0.1-300rpm)	Rollers Number	Rollers Material	Tubing Maximum Pressure (Mpa)	
MD Series	1-4	0.1-200 (rpm)	1×1	0.007-1.4 mL/min (each channel)	8 rollers	POM	Intermittent 0.1	Continuous 0.1
			2×1	0.0244-4.88mL/min (each channel)				
			2.79×0.86	0.0356-7.12mL/min (each channel)				



Multichannel Pump Head

Appearance patent: 201630636794.0
Utility model patent: 201621426687.6

MT12

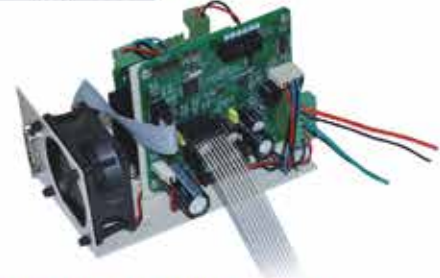
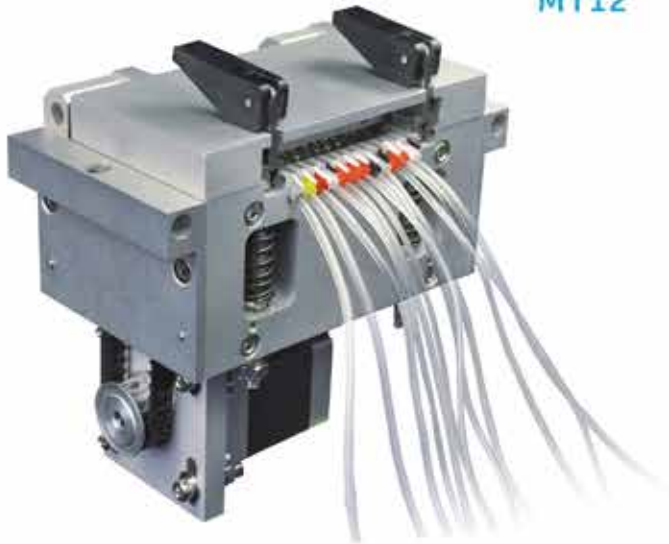

Embedded drive circuit

Dimension Drawing (Unit: mm)

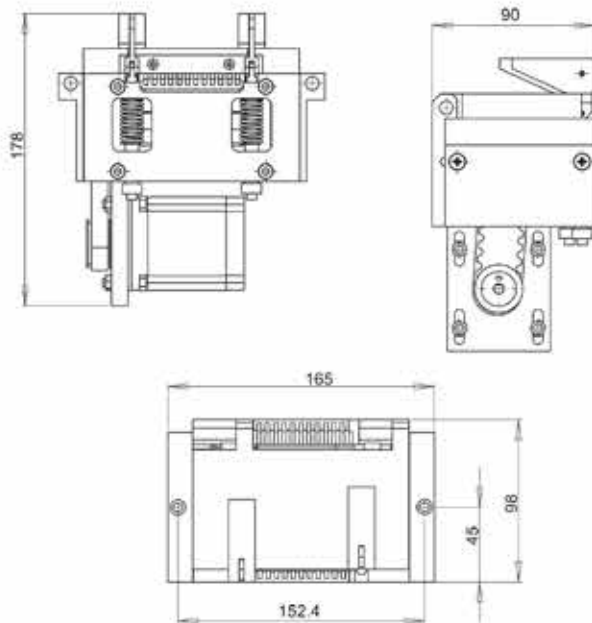

Product Introduction

The unique complete compression solve the big error problem between channels from traditional multichannel pump.

Accept many kinds of motors drive, such as stepper motor, DC motor, AC motor and servo motor.

Model Number

| MT12

Typical Application

| Support chemistry analytical instruments

Technical Specifications

Model No.	Housing Material	Rollers Material	Channel Number	Rollers Number	Speed (rpm)	Tubing and Flow Rate per channel (mL/min)				Tubing Maximum Pressure (Mpa)	
						0.51×0.9	1.02×0.86	2.06×0.86	2.54×0.86	Intermittent	Continuous
MT12	Aluminum alloy	304/316 stainless steel	12 channels	10 rollers	0.1-50	0.0016-0.84	0.005-2.5	0.015-7.5	0.020-10.5	0.2	0.15



Multichannel Pump Head

DG Series



Product Introduction

The first generation multichannel pump head is used for multichannel transfer micro liquid. Occlusion can be adjusted. Widely used in supporting analytical instruments.

Model Number

| DG-1, DG-2, DG-4, DG-6, DG-8, DG-12

Dimension Drawing (Unit: mm)

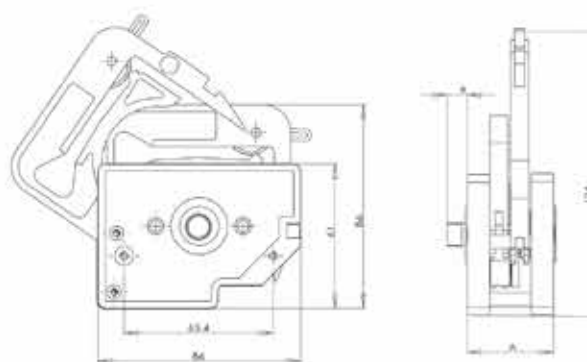

Typical Application

Widely used in supporting analytical instruments and laboratories.



DG-4, DG-6, DG-8, DG-12 use unique spanner to open the cartridge

Technical Specifications

Pump Head		DG-1	DG-2	DG-4	DG-6	DG-8	DG-12
Channel number		1	2	4	6	8	12
Tubing		Inside Diameter: 0.13–2.5mm, Wall Thickness: 0.5–1mm					
Flow rates (≤100rpm)	6 rollers	0.00008–27 mL/min(per channel)					
	10 rollers	0.000067–21.6 mL/min (per channel)					
Cartridge material		POM					
Rollers material		304 stainless steel					
Weight (kg)	6 rollers	0.21	0.27	0.40	0.54	0.67	0.95
	10 rollers	0.20	0.26	0.39	0.51	0.63	0.88



Multichannel Pump Head-MC Series

POM Material & PVDF Material



Typical Application

- | Support blood sugar analytical device.
- | Support ammonian analytical instrument.

Product Introduction

MC series new generation multichannel pump head with unique cam structure, make it much easier to operate. It is designed for small flow rates and multichannel transfer. Comparing with traditional DG pump head, it has particular cam design for micro adjustment occlusion, and also for opening the cartridge from the top. 304 stainless steel rollers assembly include two structures of 6 rollers and 10 rollers. Install silicone tubing and TYGON series imported tubing. It is widely used in supporting analytical instruments.

Dimension Drawing (Unit: mm)

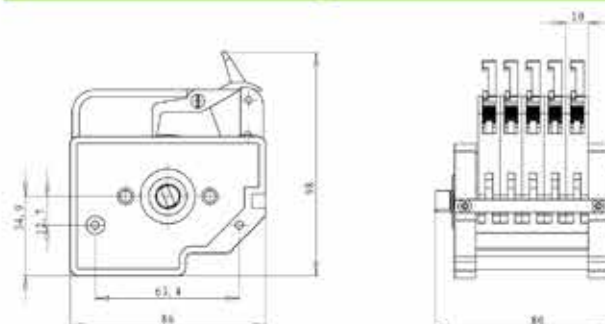

Note: Increasing or reducing one channel, the pump head size need to increase or reduce the thickness of one cartridge.



Dimension Drawing (Unit: mm)

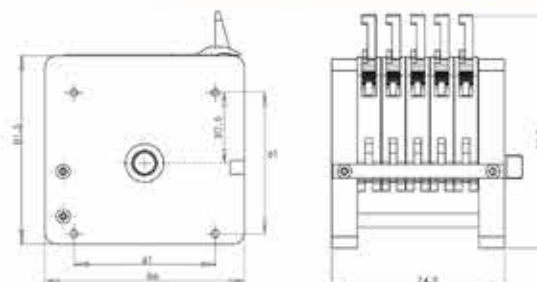

Note: Increasing or reducing one channel, the pump head size need to increase or reduce the thickness of one cartridge.

MC Pump Head VS DG Pump Head



1. The traditional DG series pump head need to open the cartridge from the bottom. It is very inconvenient to use when the space of the equipment is compact. The MC series pump head just need to open the cartridge from the top, easy to operate.

2. The gear on the MC pump head is smaller than DG, this improved the adjusting resolution.



DG Series



Multichannel Pump Head-MC Series

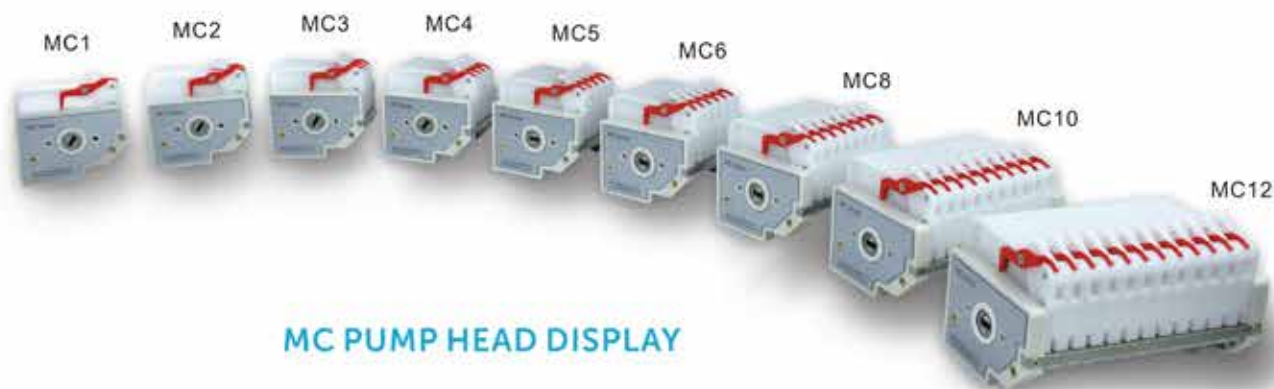

MC PUMP HEAD DISPLAY

Tubing Installation Procedure

Roller assembly
(10 roller)



A. Turn the spanner clockwise to take it off from the lever.



B. After that, the cartridge can be taken out lightly.



C. Install the tubing and confirm the working position between two adjacent clamps.



D. Embed the cartridge and press it lightly to reach the working position.



E. Turn the spanner counter-clockwise to make it reach the lever.



F. Multichannel pump heads and tubing drawing.



MC Technical Specifications

Channel number	1	2	3	4	5	6	8	10	12
Cartridge material	POM/PVDF								
Rollers material	304/316 stainless steel material								
Rollers number	6 rollers, 10 rollers								
Tubing	Speed	Flow rate of pump head with 10 rollers (mL/min)	Flow rate of pump head with 6 rollers (mL/min)	Tubing maximum pressure (Mpa)					
				Continuous	Intermittent				
1 × 1	0.1-150rpm	0.0046-6.90	0.0053-7.95	0.1	0.1				
2 × 1		0.0156-23.40	0.021-31.35						
2.4 × 0.8		0.0212-31.80	0.0274-41.10						
3 × 1		0.0324-48.60	0.043-64.95						
0.13 × 0.86		0.00016-0.24	0.000185-0.277						
0.19 × 0.86		0.0002-0.27	0.0003-0.420						
0.25 × 0.86		0.0003-0.480	0.0005-0.720						
0.51 × 0.86		0.0014-2.10	0.0020-3.0						
0.89 × 0.86		0.0039-5.85	0.0057-8.55						
1.14 × 0.86		0.0066-9.90	0.0090-13.5						
1.52 × 0.86		0.0093-13.95	0.0133-19.95						
2.06 × 0.86		0.015-22.50	0.0250-37.5						
2.79 × 0.86		0.024-35.85	0.037-55.50						

OEM Product

Multichannel Pump Head Series

OEM-B09/MC1



Dimension Drawing(Unit: mm)

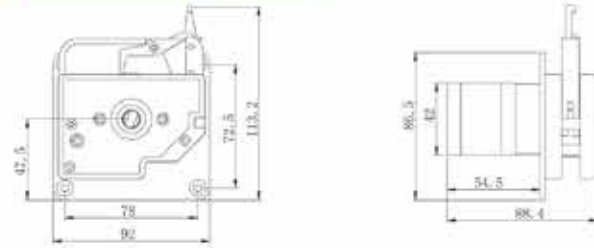

42 Stepper motor

OEM-B130/MC



Dimension Drawing(Unit: mm)

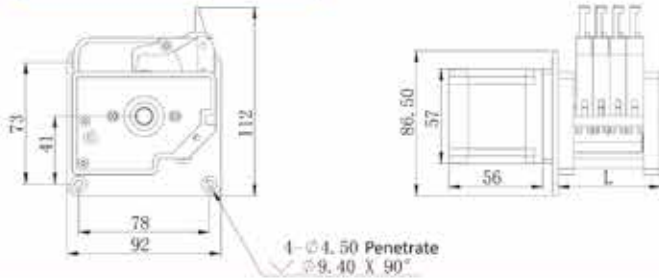

57 Stepper motor

OEM-B19/MC



Dimension Drawing(Unit: mm)

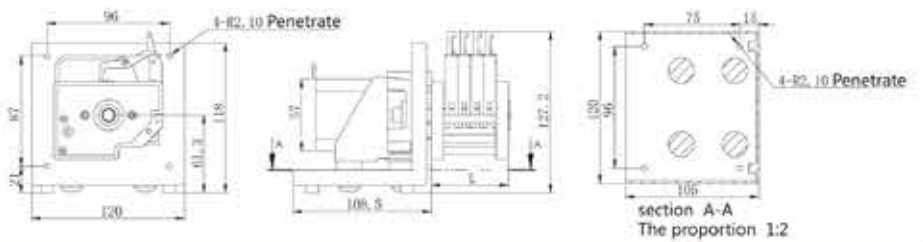

OEM-B120/DG



Dimension Drawing(Unit: mm)

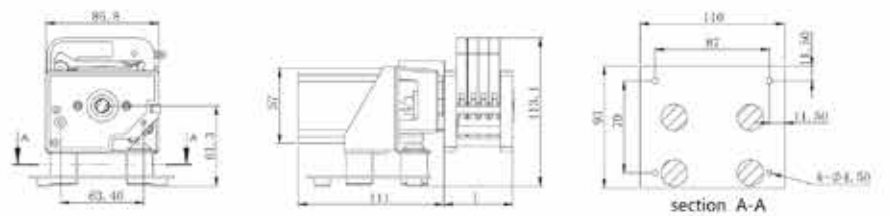

Easy Load Pump Head

YZ1515x, YZ2515x



Product Introduction

Change the tubing easily and rapidly; automatic tubing retention; accept 9 sizes tubing to meet different flow rates requests. Two kinds of material housing for customers' selection. PSF (polysulphone material): white, exquisite appearance, good rigidity, high precision, usually used in research laboratory and supporting analytical device. PPS (polyphenylene sulfide material): black, resist organic solvent corrosion, high precision and rigidity, suitable for industry or other bad working conditions. Rollers assembly with 304 stainless steel material resists corrosion with long lifetime.

Dimension Drawing (Unit: mm)

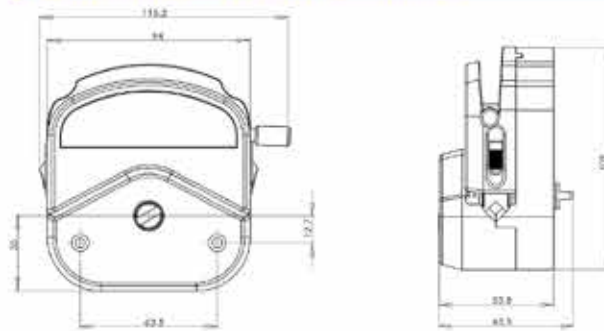

Mounting several pump heads can increase the flow rates.



YZ Series pump head has wide application, and is usually used together with many kinds of analytical instruments. According to the different technical requests, it can adopt different motors to drive, such as stepper motor, DC motor, synchronous motor, AC gear motor, etc. Stack up several pump heads can increase the flow rates.

Model Number | YZ1515x, YZ2515x

Typical Application

- | Support COD on-line monitor.
- | Support anorectal therapeutic instrument.
- | Support biofermentation cylinder.



3 rollers

6 rollers

Pump Head	Tubing	ID×Wall thickness(mm)	mL / r	Flow Rate(mL/min) (0.1~600rpm)	Tubing Max. Pressure(Mpa)		Material/Weight(kg)	
					Intermittent	Continuous	PSF	PPS
YZ1515x	13"	0.8×1.6	0.07	0.007~42	0.27	0.17	0.40 (3 rollers)	0.46 (3 rollers)
	14"	1.6×1.6	0.27	0.027~162				
	19"	2.4×1.6	0.55	0.055~330				
	16"	3.1×1.6	0.82	0.082~492	0.24	0.14	0.44 (6 rollers)	0.50 (6 rollers)
	25"	4.8×1.6	1.7	0.17~1020				
	17"	6.4×1.6	2.9	0.29~1740				
YZ2515x	18"	7.9×1.6	3.8	0.38~2280	0.10	0.07		
	15"	4.8×2.4	1.7	0.17~1020	0.27	0.17		
	24"	6.4×2.4	2.9	0.29~1740				

OEM Product

Easy Load Pump Head YZ1515x YZ2515x

OEM-B130/YZ

Dimension Drawing(Unit: mm)

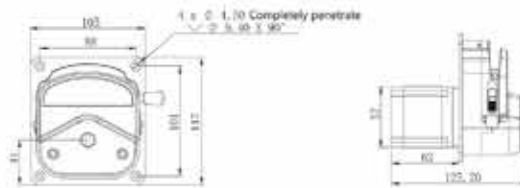

OEM-B19/YZ

Dimension Drawing(Unit: mm)

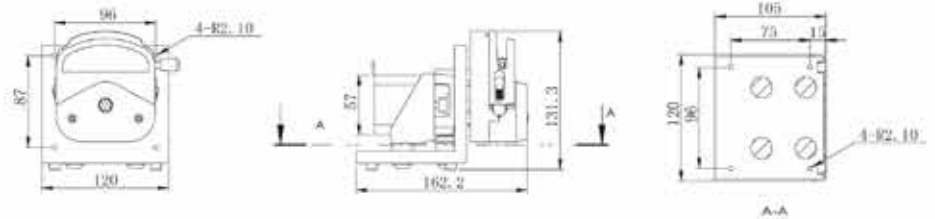

OEM-B224/YZ

Dimension Drawing(Unit: mm)

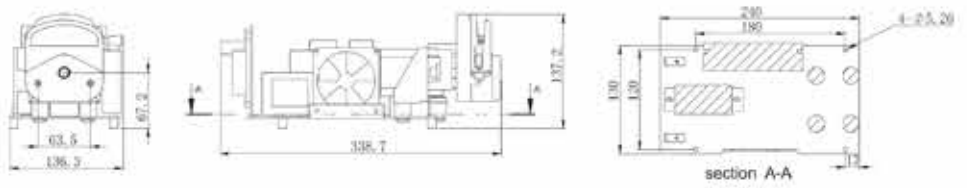

OEM-Z109/YZ (DC motor)

Dimension Drawing(Unit: mm)

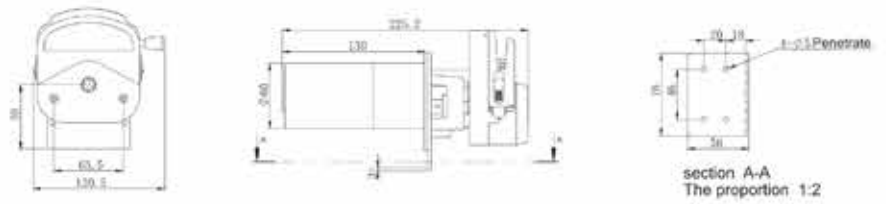

OEM-JT03/YZ (AC motor)

Dimension Drawing(Unit: mm)

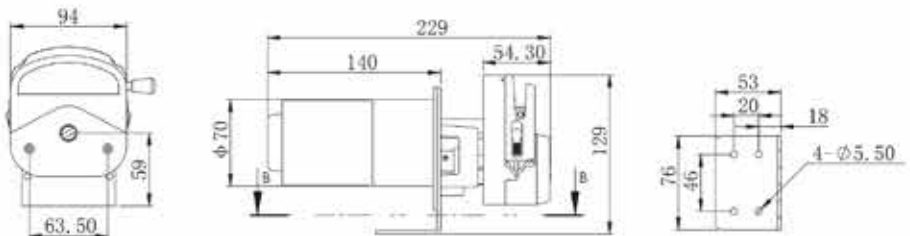

Easy Load Pump Head

HandyPump



Product Features

- | Flow rate range: 0.0033-365.69mL/min.
- | Front knob to open the pump head, save space.
- | Automatic tubing retention makes tube loading easy and quick.
- | Single and dual-channel head available.
- | 5 different sizes tubing to meet different flow rate requirements.

Dimension Drawing (Unit: mm)

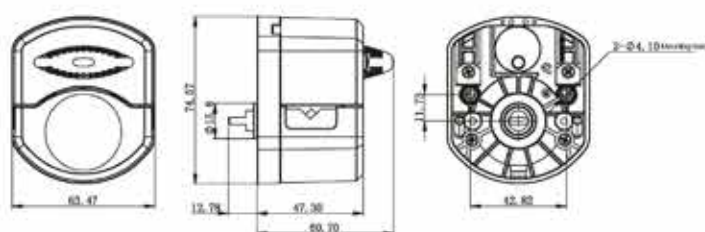

Single channel
HandyPump01



Dual channel
HandyPump02

Tubing Installation Procedure



A. Turn the knob anticlockwise 180°, open the upper pressure block.



B. Put the tube between rollers and upper block, tighten up the tubing lightly.



C. Turn the knob clockwise 180°, put the upper pressure block back to original position, fasten the tube.

Pump Head	Channel number	Tubing	ID×Wall thickness(mm)	mL / r	Speed(rpm)	Flow Rate(mL/min)	Weight(kg)
HandyPump01	Single channel	13 [#]	0.8×1.6	0.033	0.1~300	0.0033~10.03	0.224
		14 [#]	1.6×1.6	0.187		0.0187~56.09	
		19 [#]	2.4×1.6	0.371		0.0371~111.17	
		16 [#]	3.1×1.6	0.636		0.0636~190.76	
		25 [#]	4.8×1.6	1.219		0.1219~365.69	
HandyPump02	Dual channel	13 [#]	0.8×1.6	0.033	0.1~300	0.0033~10.03	0.224
		14 [#]	1.6×1.6	0.187		0.0187~56.09	
		19 [#]	2.4×1.6	0.371		0.0371~111.17	
		16 [#]	3.1×1.6	0.636		0.0636~190.76	



Easy Load Pump Head

YZ35-PPS, YZ35(Aluminum Alloy)



Model Number

| YZ35-PPS, YZ35(Aluminum Alloy)



Product Introduction

YZ35 pump head with aluminum alloy or PPS housing material. 304 stainless steel rollers assembly achieve high precision transferring liquid. Adaptive tubing cartridge structure makes it more easy to load the tubing.

YZ35 Pump Head Tubing Holder Advantages

- 01/ Fix the tubing; lower the tubing shaking during working; improve the stability and accuracy of flow rate.
- 02/ Prevent the tubing wear; extend the tubing service.



Dimension Drawing (Unit: mm)

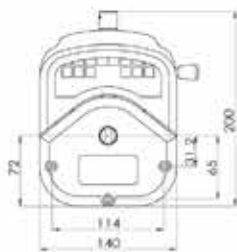

YZ35-PPS

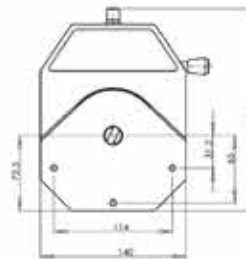

YZ35-Aluminum Alloy

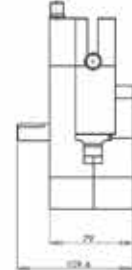

OEM-J24 Series/YZ35



Product Introduction

OEM-J24 use AC gear motor drive. YZ35 pump head is very easy to install tubing. Suitable for laboratory sampling, filling, ultrafiltration, big flow rate pumping and cement additives. It can be used separately, also can combine with other equipment.

Dimension Drawing (Unit: mm)

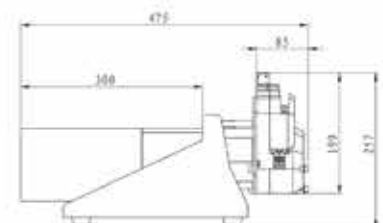
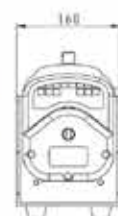

Technical Specifications

Pump Head	Tubing	ID×Wall Thickness(mm)	mL / r	Flow Rate(mL/min) (0-600rpm)	Power Supply	Motor Type	Material/Weight(kg)	
							Aluminum Alloy	PPS
YZ35	26'	6.4×3.3	6.9	<4200	Three phase 220V/380V for option	AC motor with fixed speed or adjustable speed	4.36	1.50
	73'	9.6×3.3	12.3	<7400				
	82'	12.7×3.3	20	<12000				



Standard Pump Head

SN25, SN15-14, SN15-16



Product Introduction

Standard pump head with compact structure, exquisite appearance, fixed occlusion and stable running. Can stack several pump heads, and support various equipment.

Model Number

| SN25, SN15-14, SN15-16

Typical Application

- | Use in the ice cream machine and coffee making machine
- | Support COD on-line monitor

Dimension Drawing (Unit: mm)

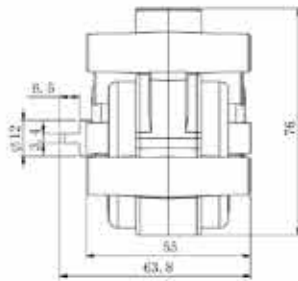
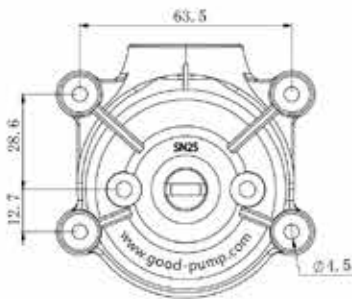

SN15-14



SN15-16

Tubing Installation Procedure

A. Disassemble the pump head, and press the tubing on the rollers.



B. Make the tubing go around the rollers one cycle, and merge it on the exit.



C. Tighten the tubing aptly, and load the other half pump head body.



Technical Specifications

Model No.	Housing Material	Rollers Material	Tubing		Flow Rate (mL/min) (0.1-600rpm)	Weight (kg)
			Tubing sizes	ID x Wall thickness		
SN15-14	PC	304 stainless steel	14"	1.6 x 1.6(mm)	0.024-144	0.20
SN15-16			16"	3.1 x 1.6(mm)	0.088-528	
SN25			24"	6.4 x 2.4(mm)	0.25-1500	

OEM Product

Standard Pump Head Series

OEM-B130/SN Series



Dimension Drawing(Unit: mm)

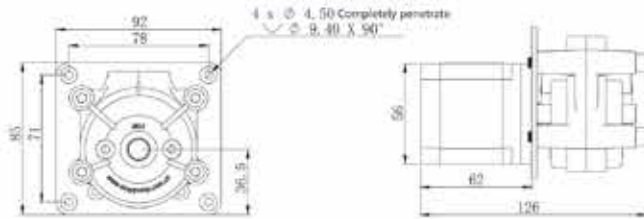

OEM-B19/SN Series



Dimension Drawing(Unit: mm)

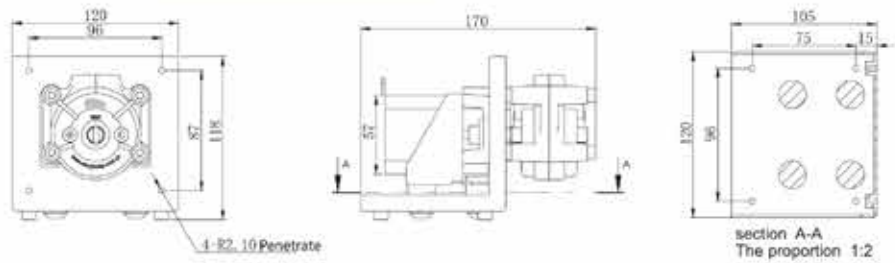

OEM-B11/SN Series



Dimension Drawing(Unit: mm)



OEM-Z109 (DC motor) /SN Series



Dimension Drawing(Unit: mm)



OEM-JT03 (AC motor) /SN Series



Dimension Drawing(Unit: mm)

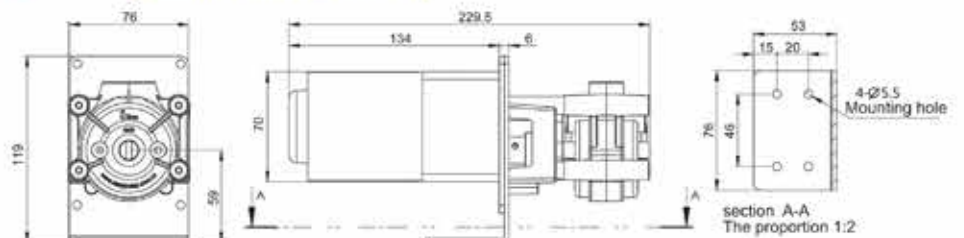

Fast Load Pump Head

DZ25-3L, DZ25-6L



Product Introduction

Easy operation, change tube rapidly. The house material is PPS (polyphenylene sulfite). 304 stainless steel rollers. DZ25 pump head use 2.4mm wall thickness tube, the flow rate range is 0.2-6000mL/min. This pump head is suitable for high viscous liquid which include granule and floc. It also suitable for high pressure request. New cartridge structure design, can use the special connector, connect low cost tubing outside the pump head to save cost; also can use flexible tube card, meet hygiene requirement.

Model Number

DZ25-3L, DZ25-6L(Aluminum Alloy)/(PPS)

Dimension Drawing (Unit: mm)

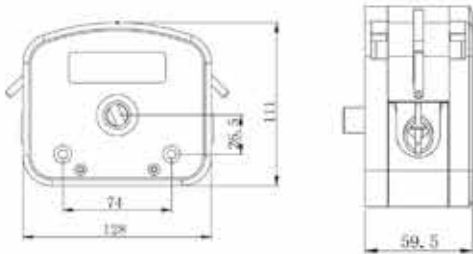

DZ25-6L Dimension



DZ25-3L Dimension

Tubing Installation Procedure

1. Lift both side levers, take off the upper block.



2. Put the tubing with cartridge or connector into pump housing.



3. Install the upper block, put down the levers to lock the block.

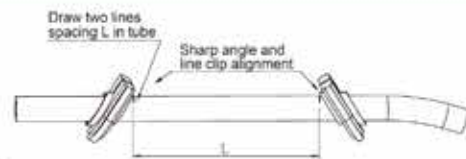

Tubing Clamp

DZ25-6L: the tubing length is 125mm between both tubing clamps.
DZ25-3L: the tubing length is 90mm between both tubing clamps.

Technical Specifications

Model No.	Housing Material	Tubing Clamp Material	Tubing		Flow Rate (mL/min) (0.1-600rpm)	Weight (kg)
			Tubing Sizes	ID x Wall Thickness		
DZ25-6L	Aluminum alloy/PPS	PP	15"	4.8 x 2.4(mm)	0.3-1800	1.86/0.86
			24"	6.4 x 2.4(mm)	0.55-3300	
			35"	7.9 x 2.4(mm)	0.8-4800	
			36"	9.6 x 2.4(mm)	1-6000	
DZ25-3L	PPS	PP	15"	4.8 x 2.4(mm)	0.211-1264	0.5
			24"	6.4 x 2.4(mm)	0.385-2310	
			35"	7.9 x 2.4(mm)	0.508-3050	
			36"	9.6 x 2.4(mm)	0.6-3600	



OEM Product

Fast Load Pump Head --DZ25-3L(PPS), DZ25-6L(PPS)

OEM-B403/DZ25-3L

Dimension Drawing(Unit: mm)

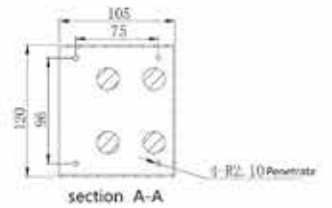
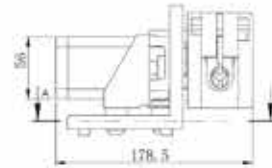

OEM-Z109/DZ25-3L(DC motor)

Dimension Drawing(Unit: mm)

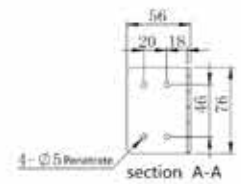
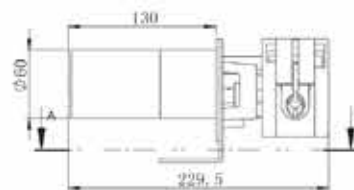
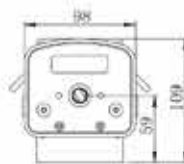

OEM-J06/DZ25-3L(AC motor)

Dimension Drawing(Unit: mm)

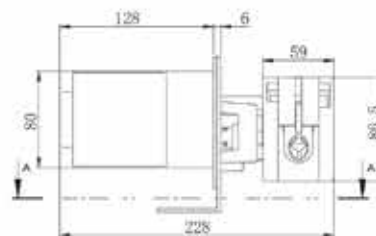

OEM-J Series/DZ25-6L(AC motor)

Dimension Drawing(Unit: mm)

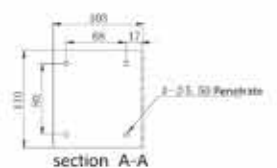
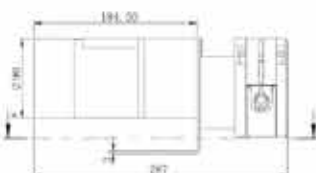
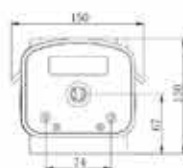

Spring Pump Head

UC15/UC20



57 Stepper motor
spring-like structure

Product Introduction

UC15/UC20 spring pump head is widely used for medical dialysis equipment. Transparent protective cover, can observe the working situation anytime; uncover signal output, stop working when uncover to ensure safety; Elastic roller assembly, running smoothly; manual lever help install the tube, and can finish liquid circulation when power down unexpectedly; support stepper motor, DC motor, AC motor and servo motor.

Typical Application

| Medical dialysis equipment.



Servo motor

Dimension Drawing (Unit: mm)

Supporting instrument 57 stepper motor

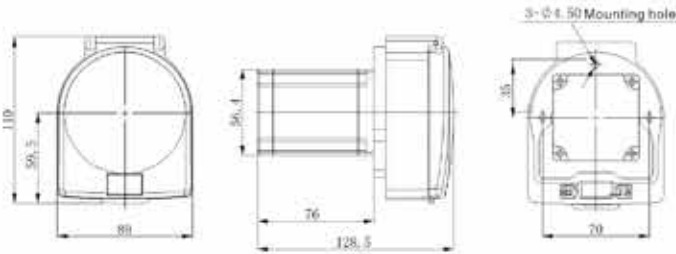

Tubing Installation Procedure



1. Press the pipe clamp, put the tube into the U shaped groove.



2. Put the tube between the two guide posts. Hold the spanner, rotate the wheel body.



3. Press the pipe clamp, put the tube into the U shaped groove.



4. Installation is finished.

Technical Specifications

Model	Housing Material		Rollers assemble construction	Tubing		Speed Range (rpm)	Flow Rate (mL/min)	Weight(kg)
	Base	Protecting cover		Size	ID×Wall(mm)			
UC15	PSF	PC	spring-like structure	19"	2.4×1.6	0.1-350	0.0875~306	1.37
				16"	3.1×1.6		0.1525~533	
				25"	4.8×1.6		0.3537~1237	
				17"	6.4×1.6		0.6488~2270	
				18"	7.9×1.6		0.7625~2668	
UC20	PSF	PC	spring-like structure	Medical dialysis tube	8×2	0.1-200	0.7650~1530	1.37

Low Pulsation Pump Head

DY15, DY25



Product Introduction

The 'low pulsation' pump head is specialized for high precision filling. Through the phase difference between the two sets of rollers, make the pulse crest and trough complementary, reducing the fluid pulsation effectively, reach high precision liquid transferring.

Model Number

| DY15, DY25

Typical Application

High precision dosing micro liquid.

*Y*connector and tubing cartridge schematic diagram

The tubing length is 125mm between two cartridges



Tubing Installation Procedure

1. Lift both side levers, take off the upper block.



2. Put the tubing with tubing clamp into pump housing.



3. Install the upper block, put down the levers to lock the block.



Dimension Drawing (Unit: mm)

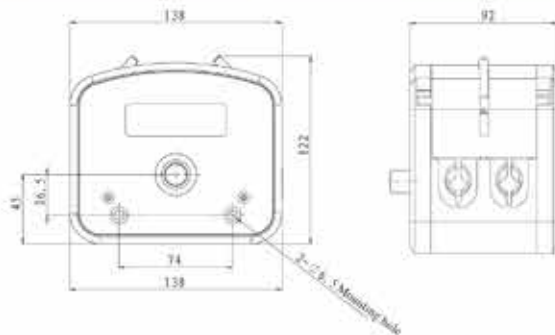

Pulsation Reduction Schematic Diagram

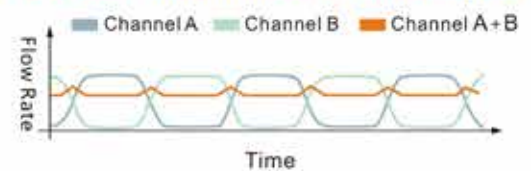

Technical Specifications

Model No.	Housing Material	Tubing Clamp Material	Tubing		Flow Rate (mL/min) (0.1-350rpm)	Weight (kg)
			Tubing Sizes	ID × Wall Thickness		
DY15	Aluminum alloy	PP	13'	0.8 × 1.6(mm)	0.01-48	3.2
			14'	1.6 × 1.6(mm)	0.06-223	
			19'	2.4 × 1.6(mm)	0.13-448	
			16'	3.1 × 1.6(mm)	0.2-723	
			25'	4.8 × 1.6(mm)	0.47-1626	
			17'	6.4 × 1.6(mm)	0.64-2230	
			18'	7.9 × 1.6(mm)	0.95-3337	
DY25	Aluminum alloy	PP	15'	4.8 × 2.4(mm)	0.42-1480	
			24'	6.4 × 2.4(mm)	0.76-2670	
			35'	7.9 × 2.4(mm)	1-3600	
			36'	9.6 × 2.4(mm)	1.24-4340	

OEM Product

User driven / speed type control board



PD03 Main board technical specification		PMD07 Main board technical specification	
Speed range	0.1–350 rpm	Speed range	0.1–350 rpm
Speed control	Pulse frequency speed control	Speed control	Preset speed or manual control
Logic input voltage	5V, 12V, 24V(default 5V)	Control mode	External passive signal level (normally closed or open) mode; control the start/stop and direction
Multiple segments	1/16(recommend), 1, 1/2, 1/4, 1/8, 1/32 1/64, 1/128	Display(optional)	0.96" OLED screen
Input voltage	DC 24V	Input voltage	DC 24V
Power	< 60W	Power	< 60W
Dimension (L*W)	98.48 × 82.68 mm	Dimension (L*W)	98.48 × 82.68 mm



PM01/PM02 Mainboard technical specification		PMD17 Mainboard technical specification	
Speed range	0.1–600 rpm(optional)	Speed range	0.1–350 rpm(optional)
Flow rate range	0.000166–2280mL/min	Flow rate range	0.000067–1330mL/min
Speed resolution	0.1 rpm	Speed resolution	0.1 rpm
Display(optional)	0.96" OLED screen(optional)	Display	0.96" OLED screen(optional)
Speed control	Preset speed or membrane keypad speed control (optional)	Speed control	Preset speed or membrane keypad speed control (optional)
Control mode	membrane keypad/Toggle switch	Control mode	Digital knob and toggle switch
External control	Start/stop,change direction signal ;Active switch signal: 5V (standard)	External control	Start/stop;Active switch signal: 5V (standard)
Communication interface	RS485 support Modbus protocol (RTU mode)	Communication interface	RS485 support Modbus protocol (RTU mode)
External control speed	0–5V, 4–20mA(standard), 0–10V (optional)	External control speed	0–5V, 4–20mA(standard), 0–10V (optional)
Motor type	57 stepper motor	Motor type	57 stepper motor
Input voltage	DC 24V	Input voltage	DC 24V
Power	< 60W	Power	< 60W



OEM Product

DC motor OEM model

Product Model	Install Method	Speed(rpm)	Speed Error	Suitable Power	Motor Type	Work Environment		
OEM-Z101	L shape connection plate	60	± 10%	DC 12V/15W	60 DC geared motor	0-40℃		
OEM-Z102	L shape connection plate	100						
OEM-Z103	L shape connection plate	166						
OEM-Z104	L shape connection plate	200						
OEM-Z105	L shape connection plate	240						
OEM-Z106	L shape connection plate	333						
OEM-Z107	L shape connection plate	400						
OEM-Z108	L shape connection plate	500						
OEM-Z109	L shape connection plate	600						
OEM-Z110	——	60						
OEM-Z111	L shape connection plate	60		DC 24V/15W				
OEM-Z112	L shape connection plate	100						
OEM-Z113	L shape connection plate	166						
OEM-Z114	L shape connection plate	200						
OEM-Z115	L shape connection plate	240						
OEM-Z116	L shape connection plate	333						
OEM-Z117	L shape connection plate	400						
OEM-Z118	L shape connection plate	500						
OEM-Z119	L shape connection plate	600						
OEM-Z201	L shape connection plate	60	± 10%	DC 12V/25W	70 DC geared motor			
OEM-Z202	L shape connection plate	100						
OEM-Z203	L shape connection plate	150						
OEM-Z204	L shape connection plate	200						
OEM-Z205	L shape connection plate	300						
OEM-Z206	L shape connection plate	450						
OEM-Z207	L shape connection plate	500						
OEM-Z208	L shape connection plate	600						
OEM-Z211	L shape connection plate	60					DC 24V/25W	
OEM-Z212	L shape connection plate	100						
OEM-Z213	L shape connection plate	150						
OEM-Z214	L shape connection plate	200						
OEM-Z215	L shape connection plate	300						
OEM-Z216	L shape connection plate	450						
OEM-Z217	L shape connection plate	500						
OEM-Z218	L shape connection plate	600						
OEM-Z301	L shape connection plate	600		± 10%			DC 24V/30W	60 DC motor
OEM-Z401	L shape connection plate	500		± 10%			DC 24V/40W	80 DC motor



OEM Product

AC motor OEM model

OEM-J						
Product Model	Install Method	Speed (rpm)	Speed Error	Suitable Power	Motor Type	Work Environment
OEM-J01	L shape connection plate	60	± 10%	AC 220V/10W	Ø 60 AC geared motor	0-40°C
OEM-J02	L shape connection plate	100				
OEM-J03	L shape connection plate	166				
OEM-J04	L shape connection plate	200				
OEM-J05	L shape connection plate	300				
OEM-J06	L shape connection plate	417				
OEM-J08	L shape connection plate	60	± 10%	AC 220V/15W	Ø 70 AC geared motor	
OEM-J09	L shape connection plate	100				
OEM-J010	L shape connection plate	166				
OEM-J011	L shape connection plate	200				
OEM-J012	L shape connection plate	300				
OEM-J013	L shape connection plate	417				
OEM-J015	L shape connection plate	60	± 10%	AC 220V/25W	Ø 80 AC geared motor	
OEM-J016	L shape connection plate	120				
OEM-J017	L shape connection plate	300				
OEM-J018	L shape connection plate	500				
OEM-J019	L shape connection plate	60				
OEM-J020	L shape connection plate	120				
OEM-J021	L shape connection plate	300	± 10%	AC 220V/60W	Ø 90 AC geared motor	
OEM-J022	L shape connection plate	500				

OEM-JT						
Product Model	Install Method	Speed (rpm)	Speed Error	Suitable Power	Motor Type	Work Environment
OEM-JT01	L shape connection plate	0-60	± 10%	AC 220V/15W	Ø 70 AC geared motor	0-40°C
OEM-JT02	L shape connection plate	0-120				
OEM-JT03	L shape connection plate	0-300				
OEM-JT04	L shape connection plate	0-500				
OEM-JT05	L shape connection plate	0-60	± 10%	AC 220V/25W	Ø 80 AC geared motor	
OEM-JT06	L shape connection plate	0-120				
OEM-JT07	L shape connection plate	0-300				
OEM-JT08	L shape connection plate	0-500				
OEM-JT09	L shape connection plate	0-60	± 10%	AC 220V/60W	Ø 90 AC geared motor	
OEM-JT10	L shape connection plate	0-120				
OEM-JT11	L shape connection plate	0-300				
OEM-JT12	L shape connection plate	0-500				

Tubing & Flow Rate		
Pump Head	Tubing	Flow Rate (mL/min)
YZ1515x	13', 14', 19', 16', 25', 17', 18'	< 1900
YZ2515x	15', 24'	< 1450
MC	ID: 0.13-3.17mm Wall thickness: 0.8-1mm	< 45
SN Series	14', 16', 24'	< 1250
DZ25-3L	15', 24', 35', 36'	< 3000
DZ25-6L	15', 24', 35', 36'	< 5000



Intelligent Syringe Pump

NEW

ISPLab01

3 years warranty



Features

- | Colorful LCD display:
Friendly interface, 4.3 inch LCD display every technical parameter in real time.
- | Input syringe inner diameter function:
Can choose the injector from the list or input the injector inner diameter directly.
- | Two measurement mode for selection:
Infusion volume --- Infusion flow rate, Infusion volume --- Infusion time.
- | 4 different working modes:
Infusion, withdrawal, infusion/withdrawal, withdrawal/infusion. The parameters of each working mode saving separately.
- | Alarm function:
The pump will stall and give an alarm when the drive structure of the pump is blocked.

Product Introduction

The intelligent syringe pump with infusion/withdrawal mode, stainless steel body, and 4.3" color LCD screen is easy to operate. It can install and fix different types of injectors or syringes in the same time, and it is suitable for transferring micro flow rates with high precision (non-medical).

Model Number

ISPLab01, ISPLab02, ISPLab04, ISPLab06, ISPLab08, ISPLab10, ISPLab12



Syringe Pump External Control Schematic

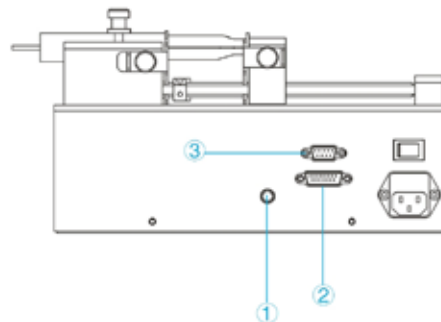

- ① Foot pedal connector:
Connect with foot pedal switch
- ② 15 Pin connector:
External input and output
- ③ 9 Pin connector :
RS232 and RS485

Real-time display flow rate

Display area for setting parameter

Display area for dynamic working

Display area for running parameter

Function setting area changeable by touching

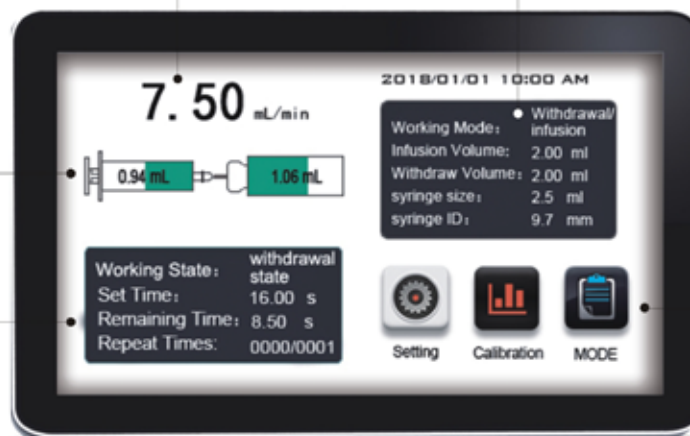

ISPLab06

3 years warranty



ISPLab10

3 years warranty



Technical Specifications

Working mode	Infusion, withdrawal, infusion/withdrawal, withdrawal/infusion						
Channel number	1	2	4	6	8	10	12
Syringe size	10 μL–140mL			10 μL–10mL			
Flow rate	0.001uL/min–127mL/min			0.001uL/min–21.997mL/min			
Drive dimension(mm)	282*209*165	282*236*158	282*209*175				
Infusion volume per microstep	0.078 μm						
Min. linear rate	5 μm/min						
Max. linear rate	132mm/min						
Min. step rate	0.035ms/Mirco step						
Max. step rate	0.937sec/Mirco step						
Max.linear force	8–20kgf, online adjust						
Advance per microstep	0.078 μm						
Back distance	0.01–10mm						
Common modes	Can save at most 60 common modes						
Accuracy	Error ≤ ±0.5% (stroke ≥ 30%maximum stroke)						
Syringe	Installed syringe size and custom syringe ID						
Display	Industrial grade 4.3" LCD color display						
Control method	Touch screen and Mechanical keypad						
Power-off memory	Display the previous data parameter after power supply again						
Output state	OC gate signal output, used to indicate running status and direction						
External control signal	Start/stop signal, withdrawal and infusion signal, active switch signal: 5V, 12V, and 24V for option; Start/stop signal, passive switch signal, such as foot pedal switch						
Communication interface	RS232/RS485, Modbus protocol(RTU mode)						
Power supply	AC 90-264V						
Condition temperature	0-40℃						
Relative humidity	<80%						
IP rate	IP31						

Syringe	Inside Diameter(mm)	Flow Rate(μ L/min – mL/min)	
		ISPLab01/ISPLab02	ISPLab04-ISPLab12
1mL	4.70	0.087–2.290	0.087–2.290
2.5mL	9.70	0.370–9.755	0.370–9.755
5mL	12.48	0.612–16.147	0.612–16.147
10 mL	15.89	0.992–26.177	0.992–26.177
20mL	20.00	1.571–41.469	—
30 mL	22.50	1.988–52.484	—
50 mL	28.90	3.280–86.588	—

Split Type Syringe Pump

SPC/ZU- I

3 years warranty

NEW



Dimension Drawing (Unit: mm)

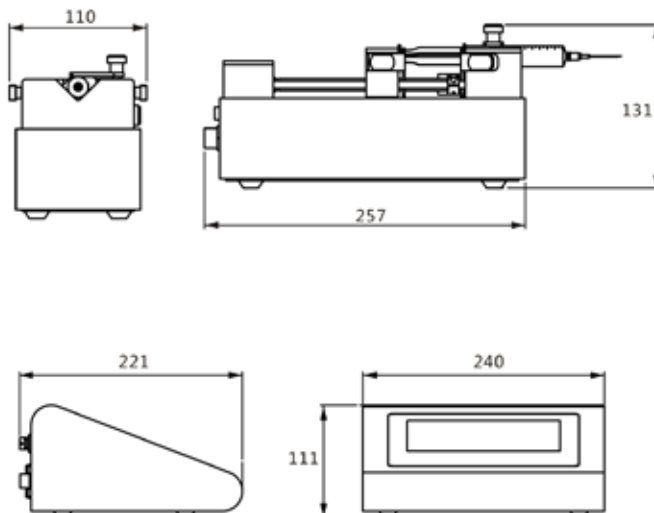

Product Introduction

The split syringe pump series consists of a controller and a number of separate syringe pump distribution units (maximum eight units). Split designs, mainly used in laboratories.

Model Number

| SPC/ZU- I

Features

- | Four running modes:
Infusion, withdrawal, infusion/withdrawal, withdrawal/infusion
- | Two working modes:
Independent working mode and logic working mode.

Under the independent operation mode every allocation unit can run as a syringe pump.

Liquid infusion and withdraw that every unit independent work and with different speed to infusion or withdraw many kinds of liquid at the same time.

Under the logical operation mode multi allocation units according to the predetermined logical relationship to infusion and withdraw with different orders and different proportion.

OCM Split type syringe pump series use 7" industrial grade true color display with touch screen control, and intelligent calibration and online micro adjust function.

Technical Specifications

Working mode (Four)	Infusion, withdrawal, infusion/withdrawal, withdrawal/infusion.	Flow rate range	0.01uL/min-127mL/min
		Speed	MAX:0.937sec/microstep Min:0.035ms/microstep
Channel number	1-8 optional	Accuracy	Stroke \geq 30% maximum stroke, Error \leq \pm 0.5%
Syringe protection	Protect the syringe from damage by adjusting the limit block position	Max.linear force	10Kgf
Traffic jam protection	After detecting traffic outage alarm function	Control and display	7" color touch screen
Syringe selection	Available of the mainly manufacturer, type and syringe from, also can define syringe ID in same time	Power-off memory	Display the previous data parameter after power supply again.
Syringe size	10uL-60mL	Flow rate accuracy	Intelligent calibration and online adjusting function
Maximun stroke	90mm	Signal input	Control the fast forward ,rewind ,start and stop.
Stoke resolution	0.078um per microstep	Communication interface	RS485/RS232
Linear velocity range	5um/min-132mm/min	Power supply	Controller AC100V-240V, Type syringe pump DC24V



Syringe Pump



SPLab02-Dual channel

Features

The syringe pump with infusion/withdrawal mode, stainless steel body, and large-screen chromatic LCD is easy to operate. It can install and fix different types of injectors or syringes in the same time, and it is suitable for transferring micro flow rates with high precision (non-medical).

Model Number

- | SPLab01(1 channel) | SPLab02(2 channels)
- | SPLab04(4 channels) | SPLab06(6 channels)
- | SPLab08(8 channels) | SPLab10(10 channels)
- | SPLab12(12 channels)



SPLab01-E

32.4 KV High Voltage Test



Typical Application

Special for high voltage electrostatic spinning

Technical Specifications

Working mode(6 kinds)	Infusion, withdrawal, infusion/withdrawal, withdrawal/infusion, continuous, additional mode (infusion/withdrawal, then exclude bubble).						
Channel number	1	2	4	6	8	10	12
Syringe size	10uL-140mL			10 μ L-10mL			
Flow rate	0.001uL/min-127mL/min			0.001 μ L/min-21.997mL/min			
Drive dimension(mm)	282*209*165	282*236*158	282*209*175				
Infusion volume per microstep	0.078 μ m						
Min. linear rate	5 μ m/min						
Max. linear rate	132mm/min						
Min. step rate	0.035ms/Mirco step						
Max. step rate	0.937sec/Mirco step						
Max.linear force	16kgf						
Advance per microstep	0.078 μ m						
Accuracy	≤ ±0.5%						
Operating mode	Rotary encoded switch and imported membrane keypad						
Display mode	320×240TFT-LCD						
Power-off memory	Display the previous data parameter after power supply again						
Power supply	AC 220V ± 10%(standard),AC 110V ± 10%(optional)						
Operating condition	Temperature 0-40°C, Relative humidity <80%						
External interface	Active switch signal: 5V						
Communication interface	RS485, Modbus protocol(RTU mode)						

Syringe	Inside Diameter(mm)	Flow Rate(μ L/min-mL/min)	
		SPLab01/SPLab02	SPLab04-SPLab12
1mL	4.70	0.087-2.290	0.087-2.290
2.5mL	9.70	0.370-9.755	0.370-9.755
5mL	12.48	0.612-16.147	0.612-16.147
10 mL	15.89	0.992-26.177	0.992-26.177
20mL	20.00	1.571-41.469	—
30 mL	22.50	1.988-52.484	—
50 mL	28.90	3.280-86.588	—



Industrial Syringe Pump



ASD60

NEW

Product Introduction

ASD60 Dilutor & Dispenser system is a programmable precision liquid handling device. Flow rate range: 0.000312–1250mL/min. Controlled by computer or microcontroller, replace the traditional operation of diluting and dispensing. Widely used in blood, chemistry, food and environment analysis.

Model Number

| ASD60

Dimension Drawing (Unit: mm)

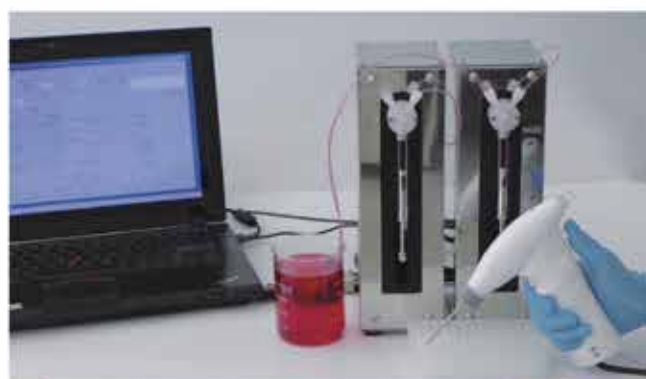
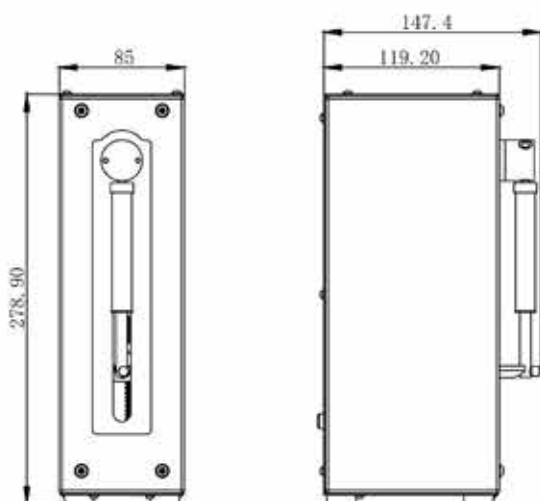

Technical Specifications

Precision	Repetition error $\leq 0.05\%$ CV at full stroke (500 μ L syringe and above), (DI water at room temperature)	Valves type	3-port 120° (Standard)
Accuracy	Error $\leq 0.5\%$ at full stroke (DI water at room temperature)	Tubing fittings	1/4–28" or M6
Plunger drive	Stepper motor driven lead screw with optical encoder for step loss detection and home flag	Syringe fittings	1/4–28"
Plunger travel	60 mm (6000 steps or 48000 steps)	Power requirements	24 VDC $\pm 10\%$ / 2.0 A (peak)
Flow rate range	0.000312–1250 mL/min	Communication interface	RS232, RS485
Run time per stroke	1.2 seconds–160 minutes	Baud rate	9600 or 38400 (RS232 and RS485)
Speed resolution	0.01 mm or 0.00125 mm	Addressing	Up to 15 individual addresses available (DIP switch)
Syringes	Sizes 50 μ L, 100 μ L, 250 μ L, 500 μ L, 1.0 mL, 2.5 mL, 5.0 mL, 10 mL, 25 mL	Input	Two inputs with 4.7k pull-ups, 5V HCMOS. For restart the paused instruct
Valve switch time	≤ 250 ms between adjacent ports	Output	Three outputs, 5V HCMOS. For synchronous external devices
		Operating temperature	15°C–40°C
		Operating humidity	20–80% RH at 40°C
		Storage temperature	–20°C–65°C



Industrial Syringe Pump

SP60-1A



Product Introduction

The SP60-1A Pump is a fully programmable, open frame, precision liquid handling pump module, designed for applications in the 5 μ L to 25 mL range. It is controlled by an external computer or microprocessor and automates pipetting, diluting, and dispensing functions.

Model Number

| SP60-1A

Features

| Unmatched application flexibility:

Fully programmable;
Can be controlled by an external computer or microprocessor;
Available with a range of syringe sizes and valve configurations.

| Faster product development:

Can speed up and simplify validation of your instruments;
Robust performance: optical encoder for step loss detection;
full control of start speed, top speed and cut-off speeds;
Programmable ramp-up and ramp-down rates;
Planned maintenance replacement of valves and syringes.

| Straight forward integration:

RS-232/RS-485 communication interfaces;
Up to fifteen SP60-1A pumps can be connected together;
Two digital inputs and three outputs for TTL level signals;
Used for synchronization with external devices.

Dimension Drawing (Unit: mm)

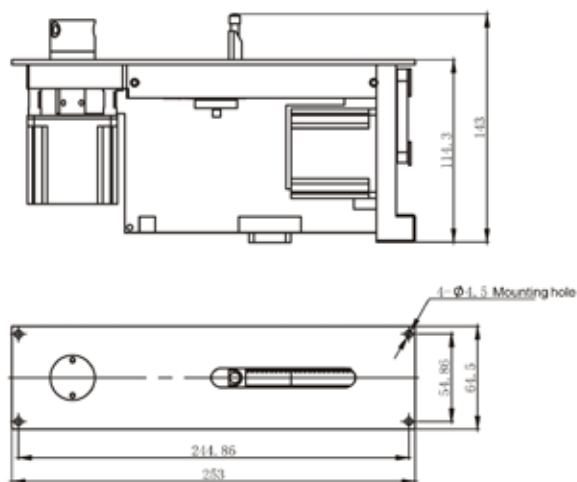

Technical Specifications

Precision	Repetition error $\leq 0.05\%$ CV at full stroke (500 μ L syringe and above), (DI water at room temperature)	Valve switch time	≤ 250 ms between adjacent ports
	Accuracy	Error $\leq 0.5\%$ at full stroke (DI water at room temperature)	Valves type
Plunger drive		Stepper motor driven lead screw with optical encoder for step loss detection and home flag	Tubing fittings
	Syringe fittings		$\frac{1}{4}$ - 28"
Plunger travel	60 mm (6000 steps or 48000 steps)	Power requirements	24 VDC $\pm 10\%$ / 2.0 A (peak)
Plunger speed	0.00625 mm/s -- 50 mm/s	Communication interface	RS-232, RS-485
Run time per stroke	1.2 seconds - 160 minutes	Baud rate	9600 or 38400 (RS-232 and RS-485)
Speed resolution	0.01 mm or 0.00125 mm	Addressing	Up to 15 individual addresses available (DIP switch)
Syringes	Sizes 50 μ L, 100 μ L, 250 μ L, 500 μ L, 1.0 mL, 2.5 mL, 5.0 mL, 10 mL, 25 mL	Input	Two inputs with 4.7k pull-ups, 5V HCMOS. For restart the paused instruct
	Barrel material Borosilicate glass	Output	Three outputs, 5V HCMOS, For synchronous external devices
	Plunger rod material Stainless steel		Operating temperature
	Plunger seal material PTFE or UHMWPE (most sizes)	Operating humidity	20-80 % RH at 40°C
		Storage temperature	-20°C -- 65°C



Industrial Syringe Pump

OEM-SP60-1

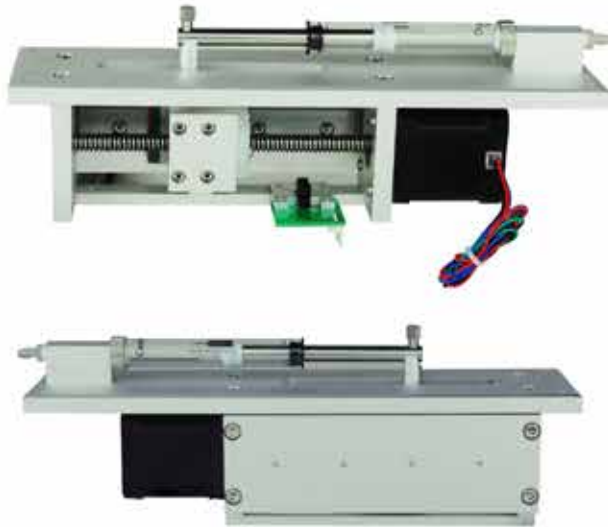

Dimension Drawing (Unit: mm)

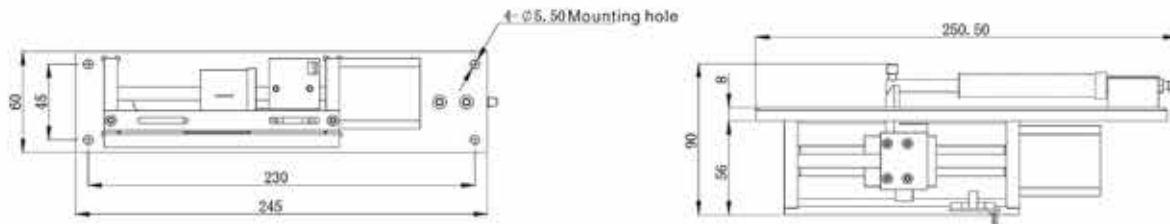

Product Introduction

Horizontal type syringe pump, aluminum support frame, 42 stepper motor, small size, light weight, compact structure. It can be customized, can install different injector. It is suitable for micro flow rate and high accuracy liquid transferring.

Application: Glue dispenser, Bio analytical instrument.

Model Number

| OEM-SP60-1

Features

- | Aluminum support frame, light weight.
- | 42 stepper motor, small volume, compact structure.
- | Stepper motor with photoelectric sensor control, high accuracy.
- | OEM products, can be customized.

Technical Specifications

Syringe size	50uL, 100uL, 250uL, 500uL, 1.0mL, 2.5mL,	Stepper motor stepping angle	1.8
	5.0mL (other sizes can be customized)	Plunger travel	0.00625mm/s—50mm/s
Rated travel	60mm	Outline dimension	245×60×90mm(L×W×H)
Motor type	Stepper motor	weight	1.2kg
Limit control	Photoelectric sensor	Working environment temperature	15℃—40℃ (Mainly affected by the use of the temperature of the syringe)
control accuracy	≤0.5% (Rated travel time)		
Stepper motor phase	2 phases	Working environment relative humidity	< 80%



Gear Pump

LabGV, LabGF, LabGN, LabGM



Features

- | With ABS engineering plastic housing, streamlined body design.
- | Brushless DC motor with high efficiency and maintenance free features.
- | The pump head is compact type, stainless steel material, driven by magnetic, low noise, no pulsation.
- | Suitable for transferring viscous, high temperature and high pressure liquid.

Model Number

- | LabGN, LabGV, LabGF, LabGM

Typical Application

- | Mainly for laboratory.

Technical Specifications

Speed range	100-3000 rpm	Communication interface	RS232, RS485 support MODBUS protocol(RTU mode)
Testing time range	0.1s-9999h	Power supply	AC 220V ± 10% 50Hz/60Hz(standard) AC 110V ± 10% 50Hz/60Hz(optional)
Outlet pressure	≤ 0.5Mpa	Drive dimension	261.4 × 157.3 × 236.9mm
Motor type	DC brushless motor	Drive weight	4.40kg
Can transfer liquid which include granules	Granule ID ≤ 20 μ m	Power consumption	<100W
Can transfer viscous liquid	Viscosity ≤ 200cSt	Condition temperature	0-40℃
External speed control signal	0-5V, 0-10V, 4-20mA for option	Relative humidity	<80%
Start/stop	Passive switch signal, such as foot pedal Active switch signal: 5V, 12V, 24V for option	IP rate	IP31

Drive	Model	Display	Operating mode	Function	Motor Status Output Interface
LabGV	Intelligent flow rate type	4.3"-industrial-true color LCD Screen	Touch screen Mechanical keypad	Flow rate/motor speed display, Fixed time and volume, Fixed volume measurement, Timer start and stop functions.	open-collector output
LabGF	Intelligent dispensing type	4.3"-industrial-true color LCD Screen	Touch screen Mechanical keypad	Input dispensing volume, dispensing time, copy numbers, for accuracy filling	open-collector output
LabGN	Standard type	3.2" LCD Screen	Mechanical keypad	Motor speed and setting datas display in the same screen, used for common transferring, support simple dispensing(0.1s-9999h)	open-collector output
LabGM	Basic type	4 digital LED	Mechanical keypad	Display motor speed, used for common transferring, support for simple dispensing (0.5s-999s)	No

Drive	Pump Head	Gear Material	Flow Rate mL/min	Output Rated Pressure(Mpa)	Fluid Temperature
LabGV LabGF LabGN LabGM	MG204XD0PT0000	PEEK	27.7 ~ 830	0.5	-30 ~ 100(℃)
	MG204XD0TT0000	PTFE	27.7 ~ 830		-30 ~ 50(℃)
	MG209XD0PT0000	PEEK	56.67 ~ 1700		-30 ~ 100(℃)
	MG209XD0TT0000	PTFE	56.67 ~ 1700		-30 ~ 50(℃)
	MG213XD0PT0000	PEEK	80 ~ 2400		-30 ~ 100(℃)
	MG213XD0TT0000	PTFE	80 ~ 2400		-30 ~ 50(℃)



Piston Pump

LabPV, LabPF, LabPM



Features

- With streamlined body design, ABS engineering plastic housing.
- Three types of motors are available: stepper motor, servo motor, DC brushless motor.
- Suitable for transmission of high temperature, high pressure liquid, widely used in laboratories, industrial and other places.

Model Number

- LabPV, LabPF, LabPM

Typical Application

- Mainly used in laboratories

Technical Specifications

Piston size code	Volume (mL/min)	Max. flow rate (mL/min)	Speed range	Max temp (°C)	Materials of construction		
					Piston	Cylinder body	Cylinder liner
RH00	0.025	0-75	0-3000	100°C	Ceramic	PVDF	Ceramic
				60°C	316SS	PVDF	Carbon
					316SS	Tefzel	Carbon
					Ceramic	Tefzel	Ceramic
RH0	0.05	0-150	0-3000	100°C	Ceramic	PVDF	Ceramic
					Ceramic	Tefzel	Ceramic
RH1	0.1	0-300	0-3000	100°C	Ceramic	PVDF	Ceramic
					Ceramic	Tefzel	Ceramic
Q0	0.08	0-144	0-1800	60°C	316SS	PVDF	Carbon
					316SS	316SS	Carbon
Q1	0.32	0-576	0-1800	100°C	Ceramic	PVDF	Ceramic
					Ceramic	PVDF	Carbon
				177°C	Ceramic	316SS	Ceramic
					Ceramic	316SS	Carbon
				60°C	316SS	PVDF	Carbon
					316SS	316SS	Carbon
Q2	0.72	0-1296	0-1800	100°C	Ceramic	PVDF	Ceramic
					Ceramic	PVDF	Carbon
				177°C	Ceramic	316SS	Ceramic
					Ceramic	316SS	Carbon
Q3	1.28	0-2304	0-1800	60°C	316SS	PVDF	Carbon
				100°C	316SS	316SS	Carbon
				100°C	Ceramic	PVDF	Ceramic



Technical Specifications

Outlet pressure	≤0.69 MPa	Power supply	AC 220V±10% 50Hz/60Hz(standard)
External speed control signal	0-5V,0-10V,4-20mA		AC 110V±10% 50Hz/60Hz(optional)
Start/stop	Passive switch signal, such as foot pedal	Drive weight	4.4Kg
	Active switch signal: 5V,12V,24V for option	Drive dimension	261.4×157.3×236.9mm
Communication interface	RS232, RS485 support MODBUS protocol(RTU mode)	Power consumption	<100W
Motor type	LabPV-L/LabPF-L/LabPM-L, Stepper motor	Condition temperature	0-40°
	LabPV-M/LabPF-M/LabPM-M, Servo motor	Relative humidity	<80%
	LabPV-H/LabPF-H/LabPM-H, Brushless DC motor	IP rate	IP31

Drive	Model	Speed Range (rpm)	Display	Operating Mode	Function	Motor Status Output Interface
LabPV	Intelligent flow rate type	LabPV-L, 0.1-600rpm	4.3"-industrial-true color LCD Screen	Touch screen + Mechanical keypad	Flow rate/motor speed display, Fixed time and volume, Fixed volume measurement, Timer start and stop functions.	open-collector output
		LabPV-M, 0.1-1800rpm				
		LabPV-H, 100-3000rpm				
LabPF	Intelligent dispensing type	LabPF-L, 1-600rpm	4.3"-industrial-true color LCD Screen	Touch screen + Mechanical keypad	Input dispensing volume, dispensing time, copy numbers, for accurate filling	open-collector output
		LabPF-M, 1-1800rpm				
		LabPF-H, 100-3000rpm				
LabPM	Basic type	LabPM-L, 0.5-600rpm	4 digital LED	Mechanical keypad	Display motor speed, used for common transferring, support simple dispensing (0.5s-999s)	No
		LabPM-M, 0.5-1800rpm				
		LabPM-H, 100-3000rpm				

Dimension Drawing (Unit: mm)

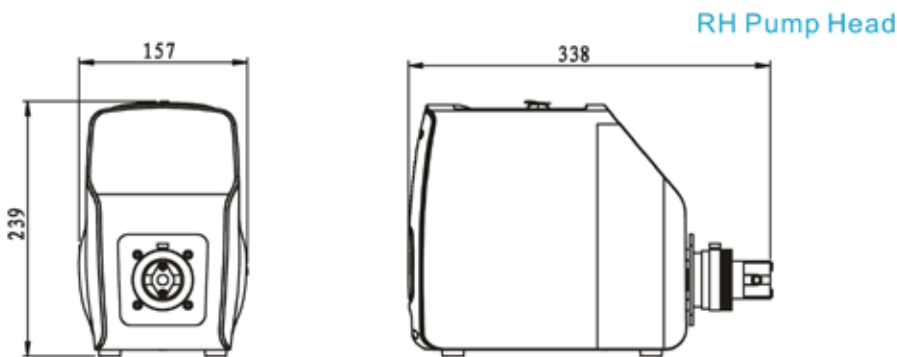

Dimension Drawing (Unit: mm)

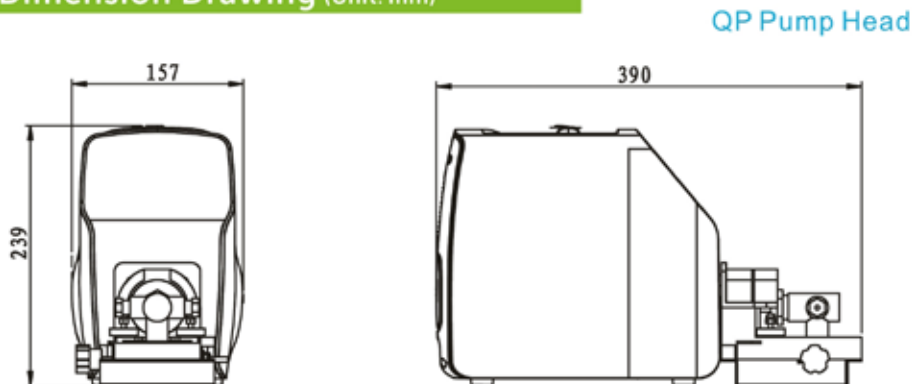

Peristaltic Pump Accessories

A Filling nozzle



When transferring or dispensing liquid reduce splashing and dropping off maximumly, most out of the splash reduction.

Dimensional tolerance $\pm 0.05\%$, assure reproducibility.

Name	Material	Tube
Filling nozzle	304/316 SS	13'/14', 19', 16', 25'/15', 17'/24'/26', 18'/35', 36'/73', 82'

B One way checkvalve



Avoid liquid drop off after filling and transferring.

C Filling Countersunk



Used for the output of tube, preventing the tube floating or absorbing the wall of container.

Name	Material	Tube
Counter sunk	304/316 stainless steel	13', 14', 19', 16', 25', 17', 18', 15', 24', 35', 36', 26', 73', 82'

D Handling Dispenser



Filling nozzle and tubing cap			
Filling nozzle size	13'	14'	19'
Inner diameter	3mm	3.5mm	4.5mm
Picture			
Filling nozzle size	16'	15'/25'	17'/24'
Inner diameter	5mm	7mm	9mm
Picture			
Tubing size	17'	18'	Plum blossom cap
Inner diameter	9.6mm	11.1mm	
Picture			

Based on ergonomics design, elegant appearance, grip feeling comfortable, easy operation. Connect to peristaltic pump external control interface, with start/stop and full speed control, can realize transferring and dispensing function. Power supply and working indicator, show the dispenser working status. With hanging hole, can be hang up when do not use.

E Foot pedal switch



Control the pump start/stop with foot pedal switch.

F Tube connector



1 Straight tube connector



2 "Y" tube connector



3 Tee tube connector



4 Reducer tube connector



5 "L" tube connector

Tube				
13"	14"	19"	16"	25"
17"	18"	15"	24"	35"
36"	26"	73"	82"	

G PH Controller



Work with peristaltic pump, can control the liquid PH value, add acid or alkali automatically.

Function:

1. Liquid: Acid-Base Solutions
2. PH value : 0-14PH
3. Set up target PH value
4. Add acid or alkali liquid automaticall
5. Control: RS485 , 4-20mA
6. Power supply: DC24V (AC220V for option)
7. Suitable temperature: 0-60°C

I Benchtop tubing cutter



Stainless steel blade, makes right-angle cuts in several sizes of plastic tubing.

J Support stand



The multiple filling stand is suitable for more than 2 channels filling. It can hold 2-8 filling nozzles. We can customize the suitable one according to your request.

H Wireless remote



When applied in the dispensing line, it can detect whether there is filling bottle in the production line. When the bottle approach the sensor side, the switch action will be made without any mechanical contact or pressure, thereby providing filling control order to the pump. In the same way, when no filling bottle is detected, the stop filling control order is provided to the pump.



Peristaltic Pump Tubing

Silicone Tubing

- Platinum-Cured Silicone Tubing
- Slightly clarity, smooth surface, low protein binding levels, fewer potential leachable.
- Ideal for pharmaceutical and biotechnology use, suitable temperature range -51 – 238 °C.

Micro Flow Rate Tubing

Tubing Size	0.13×0.86	0.5×0.86	0.86×0.86	1.52×0.86	2.06×0.86	2.79×0.86	1×1	2×1	3×1	2.4×0.8
Tubing cross sections (1:1)										
Wall thickness (mm)	0.86						1.0		0.8	
Inside diameter (mm)	0.13	0.5	0.86	1.52	2.06	2.79	1.0	2.0	3.0	2.4
Maximum pressure (Mpa)	Continuous						0.1			
	Intermittent						0.1			

Basic Flow Rate Tubing

Tubing Size	13'	14'	19'	16'	25'	17'	18'	15'	24'	35'	36'		
Tubing cross sections (1:1)													
Wall thickness	mm						1.6		2.4				
	inch						1/16		3/32				
Inside diameter	mm		3.1		4.8		6.4		7.9		9.6		
	inch		1/8		3/16		1/4		5/16		3/8		
Maximum pressure (Mpa)	Continuous			0.17		0.14		0.1		0.07		0.17	
	Intermittent			0.27		0.24		0.14		0.1		0.27	





Industrial Tubing

Tubing Size	26'	73'	82'	86'	90'	88'	92'	
Tubing cross sections (1:1)								
Wall thickness	mm		3.3		6.3		4.8	
	inch		1/8		1/4		3/16	
Inside diameter	mm		9.6		12.7		12.7	
	inch		3/8		1/2		1/2	
Maximum pressure (Mpa)	Continuous			0.2		0.25		
	Intermittent			0.27		0.3		





Peristaltic Pump Tubing

SAINT-GOBAIN Tubing: Tygon, PharMed BPT, Norprene etc

	A Tygon3350	B Tygon E-3603	C Norprene Chemical	D PharMed	E Norprene A-60-F
					
Formulation	Tygon3350	Tygon R-3603	Norprene Chemical	PharMed	Norprene A-60-F
Application	Pharmaceutical, cosmetic, medical and auto-analysis application.	General laboratory, food & beverage, biopharmaceutical, analytical instruments.	Excellent for chemical processing and general industrial applications. Food and beverage applications where extractables are a concern.	Cell and tissue culture work and pharmaceutical uses. Also good for light-sensitive samples.	Ideal for the food, dairy and beverage.
Advantages	Ultra-smooth; minimizes bacterial growth. Good for mild to medium concentration bases, salts and alcohols; odorless, tasteless, and nontoxic. Transparent.	Inexpensive tubing for general lab application. Nonaging, nonoxidizing. Clear for easy flow monitoring. Handles virtually all inorganic chemicals. Low gas permeability. Smooth bore; good for viscous fluids. High dielectric constant.	Norprene thermoplastic elastomer outer jacket with chemically inert Tygon® 2075 inner bore for excellent chemical resistance. Plasticizer-free to guard against extractables. Long flex life. Opaque beige.	Great for tissue and cell work-nontoxic and nonhemolytic; long service life minimizes risk of fluid exposure; reduces tubing costs and pump downtime. Opaque to UV and visible light to protect light-sensitive fluids. Heat sealable, bondable, and formable. Extremely low gas permeability.	Heat, ozone, and UV light resistant. Nonaging; nonoxidizing; superior acid and alkali resistance. Opaque beige.
Application Suitability	—————	ACIDS GOOD ALKALIES GOOD ORGANIC SOLVENTS NO PRESSURE GOOD VACUUM GOOD VISCIOUS FLUIDS EXCELLENT STERILE FLUIDS GOOD	—————	ACIDS GOOD ALKALIES GOOD ORGANIC SOLVENTS NO PRESSURE GOOD VACUUM EXCELLENT VISCIOUS FLUIDS GOOD STERILE FLUIDS EXCELLENT	—————
Physical characteristics	—————	Thermoplastic. PVC-based material with plasticizer. Firm (stiff) material. Transparent, clear.	—————	Thermoplastic elastomer. Polypropylene-based material with USP mineral oil. Excellent tensile strength. Firm (stiff) material. Opaque, beige.	—————
Temp. range	-75 to 450° F (-60-232° C)	-58 to 165° F (-50-74° C)	-76 to 165° F (-60-74° C)	-60 to 270° F (-59-135° C)	-60 to 275° F (-51-135° C)
Meets classifications	FDA 21 CFR 177.2600 USP Class VI EP 3.1.9. Exceeds 3A standards. Manufactured according to GMP.	FDA 21 CFR 175.300	None.	None.	FDA 21 CFR 177.2600 NSF listed (Standard 51) Manufactured according to GMP.
Cleaning/ Sterilization	Ethylene oxide gamma irradiation, or autoclave for 30 min, 15psi (1 bar).	Unaffected by commercial sanitizers (with recommended procedures) Sterilize with ethylene oxide (ETO) or autoclave. To autoclave: Coil loosely in nonflaming cloth or paper, autoclave at 121°C (250°F), 1KG/cm ² (15psi) for 30 minutes (tubing will appear milky); air dry at max 66°C (150°F) for 2 to 2 ½ hours until clear.	Sterilize with ethylene-oxide(ETO), autoclave or gamma irradiation up to 2.5Mrad. Repeated autoclaving will not affect overall life.	Autoclave, ethylene oxide, or gamma irradiation.	Autoclave.



Peristaltic Pump Tubing

	F Norprene A-60-G 	G Tygon F-4040-A 	H Tygon LFL 	I TYGON 2475 	K Viton 
Formulation	Norprene A-60-G	Tygon F-4040-A	Tygon LFL	TYGON 2475	Viton
Application	For applications requiring excellent chemical, heat, ozone, and ultraviolet (UV) light resistance.	Fuels and industrial lubricants-gasoline, kerosene, heating oils, cutting compounds, and glycol-based coolants. Resists most hydrocarbons.	General laboratory use, provides longer life with peristaltic tubing pumps.	Sensitive fluid transfer applications requiring high purity.	Acid and solvent transfer, high-temperature.
Advantages	Best choice for vacuum/pressure applications. Offers longest life with good flow consistency. Heat and ambient ozone resistant. Good resistance to acids/alkalies. Black color hides dirt and dust. Heat sealable, nonaging, and nonoxidizing. High dielectric constant.	Resists embrittlement and swelling, ozone-and UV-resistant, with low-extractability. Translucent yellow.	Longest life of all Tygon® peristaltic tubing (1000hrs). Nonaging, nonoxidizing, clear for easy flow monitoring. Broad chemical resistance; low gas permeability. Smooth bore. Good for viscous fluids. High dielectric constant.	Plasticizer free, smooth inner surface (inhibits particulate buildup and bacterial growth), safely disposed of through incineration and nontoxic. Transparent.	The most chemical resistant tubing. Registant to corrosives, solvents, and oils at elevated temperatures. Low gas permeability.
Application Suitability	ACIDS GOOD ALKALIES GOOD ORGANIC SOLVENTS NO PRESSURE EXCELLENT VACUUM EXCELLENT VISCIOUS FLUIDS EXCELLENT STERILE FLUIDS NO	—————	ACIDS GOOD ALKALIES GOOD ORGANIC SOLVENTS NO PRESSURE GOOD VACUUM GOOD VISCIOUS FLUIDS EXCELLENT STERILE FLUIDS POOR	—————	ACIDS EXCELLENT ALKALIES EXCELLENT ORGANIC SOLVENTS EXCELLENT PRESSURE GOOD VACUUM GOOD VISCIOUS FLUIDS GOOD STERILE FLUIDS FAIR
Physical characteristics	Thermoplastic elastomer. Polypropylene-based material with USP mineral oil. Excellent tensile strength. Firm (stiff) material. Opaque, black. Manufactured according to GMP.	—————	Thermoplastic. PVC-based material with plasticizer. Firm (stiff) material. Transparent, clear.	—————	Thermal set rubber. Viton B (67% fluorine) Firm (stiff) material. Opaque, black. Manufactured according to GMP.
Temp. range	-60 to 270° F (-59-135° C)	-35 to 165° F (-37-74° C)	-58 to 165° F (-50-74° C)	-94 to 125° F (-70-52° C)	-25 to 400° F (-32-205° C)
Meets classifications	None.	Meets NSF-51 and 3A sanitary standards.	USP Class VI, FDA 21 CFR 175.300	FDA 21 CFR 177.1520, USP 23 Class VI, Manufactured according to GMP.	None.
Cleaning/Sterilization	Sterilize by autoclave only.	Not recommended.	Sterilize by ETO/autoclave. Coil loosely in nonlinting cloth or paper; autoclave at 250°F(121°C), 15 psi (1kg/cm²), 30 minutes (tubing will appear milky); air dry at max 150°F (66°C) for 2 to 2 ½ hrs until clear.	Ethylene oxide or gamma irradiation.	Sterilization is not recommended.





레보딕스(주) 홈페이지에 방문하시면 더욱 다양한 제품을 만나보실 수 있습니다
www.revodix.co.kr | sales@revodix.co.kr

본 사

(12930) 경기도 하남시 조정대로 150 (덕풍동)
하남지식산업센터 ITECO 334호
| TEL 031-790-1907 | FAX 031-790-1908 |

대전지사

(34016) 대전광역시 유성구 테크노3로 65 (관평동)
한신에스메카 415호
| TEL 042-824-5167/8 | FAX 042-824-5169 |

오송지사

(28576) 충청북도 청주시 흥덕구 공단로 134 (송정동)
세중테크노밸리 1012호
| TEL 070-7835-1344 | FAX 042-824-5169 |

