



MMM Group

Instructions for use

Cooling incubator with controlled humidity – EVO line

CLIMACELL 111, 222, 404, 707, 1212

CE



Congratulations on purchase of the new cooling incubator with controlled humidity which is an ideal option for applications in which you need to maintain or regulate temperature and relative humidity inside of the chamber in various time modes. In case of optional equipment purchase, it will also allow you to measure and control concentration of CO₂ in the chamber respectively other gases, intensity of lighting in the visible light zone or UV.

The incubator control uses the newest hardware components and know how in the field of regulation using Fuzzy – logics. The whole control system arranges high precision of temperature regulation, regulation of humidity and possibly other items and so it arranges higher reliability of the whole process.

The devices meet the technical and legislative requirements and they are constructed in compliance with relevant EN standards. They are manufactured from high-quality materials using the newest technologies. Each individual unit passes a thorough output control and it is tested by testing programs.

If you will follow these instructions, the device will become your reliable and powerful partner.

As from today, all these qualities are at your disposal.

This device is really easy to use, thanks to intuitive control with wizards, but anyway we do recommend you to carefully read the Instructions for Use to be able to use in full all and any features of the device and to get to know all the information necessary for its optimal use.

CONTENTS:

31. 1. 2014

1	PRODUCT NAME.....	3
2	PURPOSE AND USE.....	3
2.1	BASIC CHARACTERISTICS.....	3
3	DEVICE DESCRIPTION.....	4
3.1	GENERAL VIEW OF CLIMACELL EVO 111, 222.....	4
3.2	GENERAL VIEW OF CLIMACELL EVO 404, 707.....	5
3.3	COMMUNICATION PANEL.....	6
3.4	CONTROL PANEL.....	7
3.5	USEFUL SPACE.....	7
4	TECHNICAL DATA I.....	8
4.1	GENERAL DATA.....	8
4.2	ELECTRIC INSTALLATION AND OTHER CONDITIONS.....	8
4.3	COMMUNICATION INTERFACE.....	9
5	BASIC EQUIPMENT.....	9
6	ADDITIONAL EQUIPMENT.....	9
6.1	INTERNAL LIGHTING.....	9
6.2	BUSHINGS WITH DIAMETER 25, 50, 100 MM.....	10
6.3	MECHANIC LOCK OF THE DOOR.....	10
6.4	ELECTRIC LOCKING (BLOCKING) OF THE DOOR.....	10
6.5	DOOR HINGED ON THE LEFT.....	10
6.6	INDEPENDENT SENSOR PT 100.....	10
6.7	COMMUNICATION SW (WARMCOMM 4) FOR PC WITH WINDOWS.....	10
6.8	POTENTIAL – FREE CONTACT FOR ALARM REPORTS.....	10
6.9	INNER SWITCHED SOCKET.....	10
6.10	EXPOSITION LIGHTING.....	11
6.10.1	EXPOSITION LIGHTING IN DOORS.....	11
6.10.2	EXPOSITION LIGHTING ON RACKS.....	11
6.11	SENSORS FOR MEASURING THE INTENSITY OF UV AND VIS EXPOSITION LIGHT IN THE CHAMBER.....	11
6.12	TEMPERATURE RANGE FROM - 20 °C.....	11
6.13	CHAMBER DE-CONTAMINATION.....	11
6.14	REGULATION OF CO ₂ CONCENTRATION.....	11
6.15	COMMUNICATION MODULE WITH ETHERNET, WIFI, USB HOST.....	11
6.16	PRINTER DPT - 6333.....	11
6.17	ANDROID APPLICATION FOR DEVICE STATUS MONITORING.....	11
7	PUTTING THE DEVICE INTO OPERATION.....	12
7.1	UNPACKING AND CONTROL.....	12
7.2	IMPORTANT WARNINGS.....	12
7.3	DEVICE PLACEMENT.....	13
7.4	CONNECTION TO WATER SOURCE AND WASTE.....	13
7.5	CONNECTION TO DISTRIBUTION NETWORK.....	14
8	DEVICE STAFF.....	14
8.1	DEVICE SWITCH-ON.....	14
8.2	BASIC MENU.....	14
8.3	DEVICE USER MENU.....	14
8.3.1	NATIONAL ENVIRONMENT.....	15
8.3.2	USER ADMINISTRATION.....	15
8.3.2.1	WITHOUT USER ADMINISTRATION MODE.....	15

8.3.2.2	ADVANCED USER ADMINISTRATION.....	15
8.3.2.2.1	ACTIVATING ADVANCED USER ADMINISTRATION.....	16
8.3.2.2.2	CHANGING USER PASSWORD.....	17
8.3.2.2.3	LOGGING OUT.....	17
8.3.3	WARNINGS AND ERRORS.....	17
8.3.3.1	CURRENT ERROR MESSAGES.....	17
8.3.3.2	HISTORY OF FAULTS.....	18
8.3.4	DISPLAY AND SOUNDS.....	18
8.3.5	DEVICE MAINTENANCE MENU.....	19
8.3.5.1	SINGLE DEFROSTING.....	19
8.3.5.2	DECONTAMINATION.....	19
8.3.5.3	DRYING.....	20
8.3.6	CURRENT DATE AND TIME SETTING.....	20
8.3.7	COMMUNICATION – ACTIVATION.....	21
8.3.7.1	WIFI CONNECTION ACTIVATION.....	21
8.3.7.2	E-MAIL ACCOUNT ACTIVATION.....	22
8.3.7.3	WIFI CONNECTION VIA INTERNET BROWSER.....	22
8.3.8	PRINT.....	23
8.3.8.1	PROTOCOL PRINTING.....	24
8.3.9	BACKUP.....	24
8.3.10	SERVICE SETTING.....	24
8.3.10.1	COMMUNICATION – SETTINGS.....	24
8.3.10.1.1	ETHERNET SETTING.....	25
8.3.10.1.2	WIFI SETTING.....	25
8.3.10.1.3	E-MAIL SETTING.....	26
8.3.10.2	TOUCH PANEL CORRECTION.....	26
8.3.10.3	UNITS.....	26
8.3.10.4	RACK.....	27
8.3.10.5	AUDIT TRAIL.....	27
8.3.10.6	OVERVIEW OF INPUTS AND OUTPUTS.....	28
8.3.10.6.1	ANALOGUE ITEMS.....	28
8.3.10.6.2	DIGITAL INPUTS AND OUTPUTS.....	28
8.3.11	TESTS.....	28
8.3.11.1	COOLING TEST.....	28
8.4	PROGRAMS.....	29
8.4.1	LIST OF PROGRAMS.....	29
8.4.2	DEFINITION OF PROGRAM.....	29
8.4.2.1	SAFETY THERMOSTAT.....	29
8.4.3	PROGRAM CONFIGURATION.....	30
8.4.4	SEGMENT SETTINGS.....	31
8.4.4.1	SETTING OF PROGRAMS WITH LIGHT EXPOSITION.....	31
8.4.4.2	ALARMS.....	32
8.4.5	TEMPERATURE AND RELATIVE HUMIDITY SETTING AND THEIR LIMITATIONS.....	32
8.4.6	PROGRAM START MENU.....	33
8.4.7	PROGRAM START.....	33
8.4.7.1	RUNNING PROGRAM GRAPH.....	34
8.4.7.2	RUNNING THE PROGRAM WITH LIGHT EXPOSITION.....	34
8.4.7.3	POSTPONED START OF PROGRAM.....	34
8.4.7.4	DOOR OPENING.....	35
8.4.7.5	DOOR BLOCKING.....	35
8.4.7.5.1	DOOR BLOCKING IN THE MODE WITHOUT USERS ADMINISTRATION.....	35
8.4.7.5.2	DOOR BLOCKING IN THE MODE OF ADVANCED USERS ADMINISTRATION.....	36
8.4.7.6	CURRENTLY RUNNING PROGRAM EDITING.....	36
8.4.7.7	POWER SUPPLY OUTAGE.....	37
8.5	HISTORY OF PROTOCOLS.....	37
8.6	SYSTEM INFORMATION.....	38

9	LIST OF ERROR MESSAGES.....	39
10	DEVICE MAINTENANCE.....	41
10.1	MAINTENANCE PLAN.....	41
10.2	DOOR SEALING REPLACEMENT.....	42
10.3	DOOR ADJUSTMENT.....	42
10.4	ACCUMULATION OF CONDENSED WATER STEAM.....	43
10.5	DEVICE CLEANING AND DECONTAMINATION.....	43
10.6	STEAM GENERATOR.....	44
10.7	REVISION OF ELECTRO PARTS.....	44
11	TECHNICAL DATA II.....	45
11.1	OPERATION DATA.....	45
11.2	RACKS WITH EXPOSITION LIGHTING.....	46
12	WARRANTY AND SERVICE.....	47
13	TRANSPORT AND STORAGE.....	47
14	WAY OF LIQUIDATION.....	47

1 PRODUCT NAME

The Instructions for use apply to the below stated device models:

Type	Model	Trade Name	ZP	Type Construction Design
CLC - E	CLC kkk-c	CLIMACELL	-	Evo automatics – touch screen

E – EVO (Evolution)

kkk – chamber size 111, 222, 404, 707, 1212

c – cooling up to -20 °C.

2 PURPOSE AND USE

The device CLIMACELL EVO is designed for applications requiring precise and reproducible simulation of variable climatic conditions. In its basic version, the incubator allows simultaneous regulation of temperature and humidity. In case of additional equipment purchase it offers regulations of concentration of CO₂ respectively other gases or space – homogenous lighting in the field of visible or UV light with adjustable intensity and possibility of intensity measuring using special sensors. Thanks to the unique combination the device offers the user with extensive possibilities of use. CLIMACELL EVO can be used in biology, food processing industry, chemical industry, electrical technology, histology, botany, pharmacy and others. A typical example may be the cultivation of plant and tissue cultures or tests of stability (photo stability) of materials and medicaments.

2.1 BASIC CHARACTERISTICS

- In the operation space of the device it is possible to simulate the environment with temperature 0 up to 100 °C (-20 °C up to 100 °C for model „c“), relative humidity (hereinafter referred to as RH) 10 % up to 95 %. For possible combinations of temperature and RH see chapter 8.4.5 .
 - Possibility of chamber decontamination / sterilization at 160 °C.(this function is not designed for sterilisation of samples or material).
 - Control of space – homogenous lighting with wave length in visible and UV zone. The light exposition may be monitored using optional sensors.
 - Regulation of CO₂ in the range from 0 up to 20 % (0-2000 ppm), max. temperature 55 °C. (respectively of other gases).
 - Temperature, RH, lighting and concentration of CO₂ (respectively of other gases) may be regulated in various time modes.
 - Tested samples are stored on racks supplied together with the device.
- The unique system of air circulation with forced circulation guarantees space – homogenous distribution of temperature and RH in the whole operation space of the device.
 - Set speed of fan from 0 to 100 % in ten – percent intervals.
 - The chamber and all the inner parts are made of stainless steel. The outer shell is made partially of zinc-coated and stainless steel material and it is treated with water-soluble stove enamel (environment - friendly).
 - CLIMACELL EVO is equipped with a multi-processor control with the following characteristics:
 - Precise regulation of temperature, humidity, lighting and CO₂ (gas) with application of the newest trends in the field of regulation (fuzzy logic), supported by many years of experience of the company BMT in this field.
 - Graphic display with touch panel allows simple and intuitive control.
 - Wide offer of communication interfaces - Ethernet, Wifi, USB, RS232. – according to optional equipment
 - As many as 100 freely adjustable programs. Each program may consist from up to 100 partial segments.
 - Possibility of structuring the users into groups with differentiated access rights to the operation and service settings of the device.
 - In internal memory of the device there is automatically saved the record of the course of regulation including audit trail, total length of recording up to one year.
 - The user has the possibility to make backup of some device settings and record of the regulation on the SDHC card, flash disc or some other large-capacity memory USB device.
 - Support of WarmComm4 software for regulation progress recording.

3 DEVICE DESCRIPTION

3.1 GENERAL VIEW OF CLIMACELL EVO 111, 222

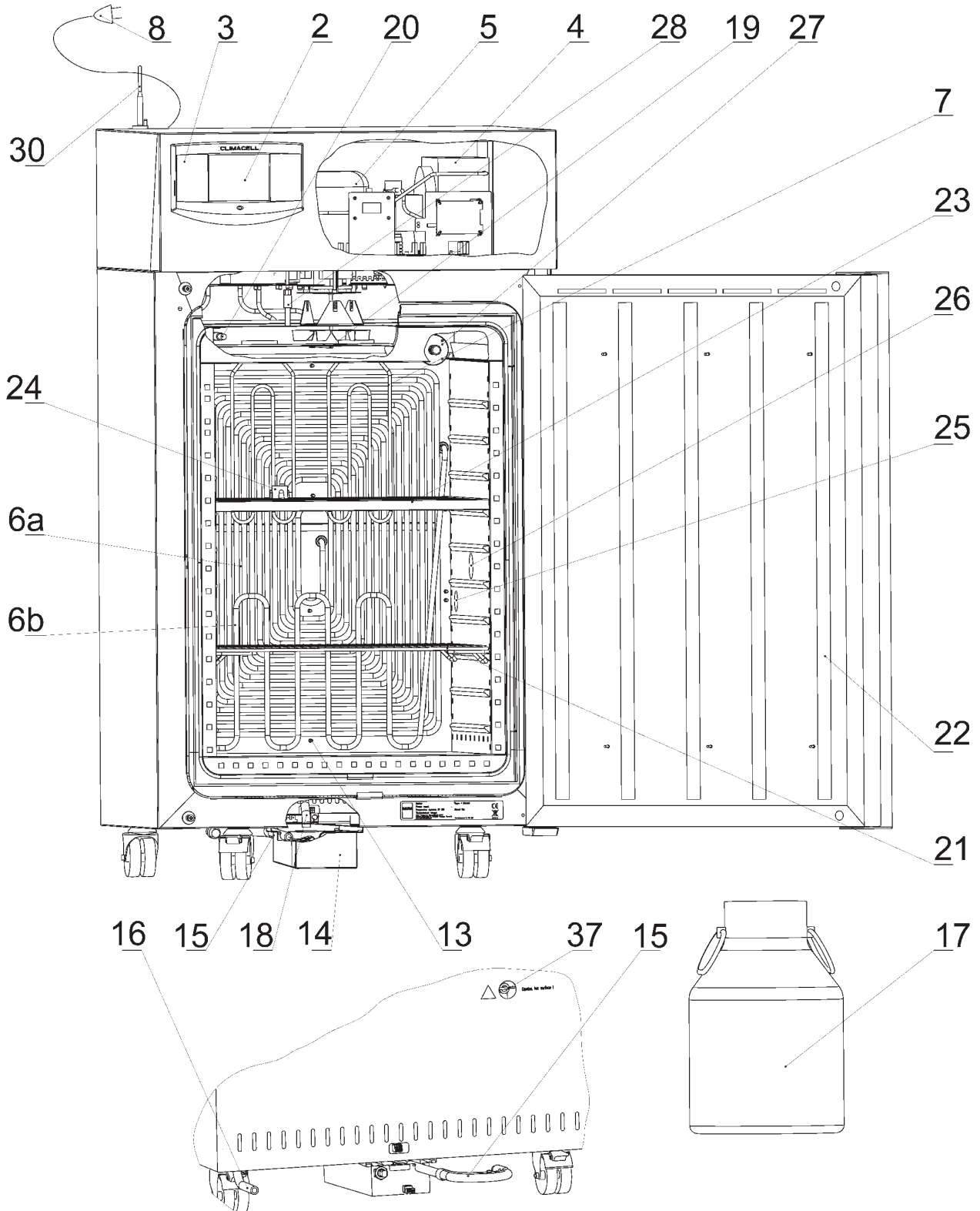

Fig. 1

3.2 GENERAL VIEW OF CLIMACELL EVO 404, 707

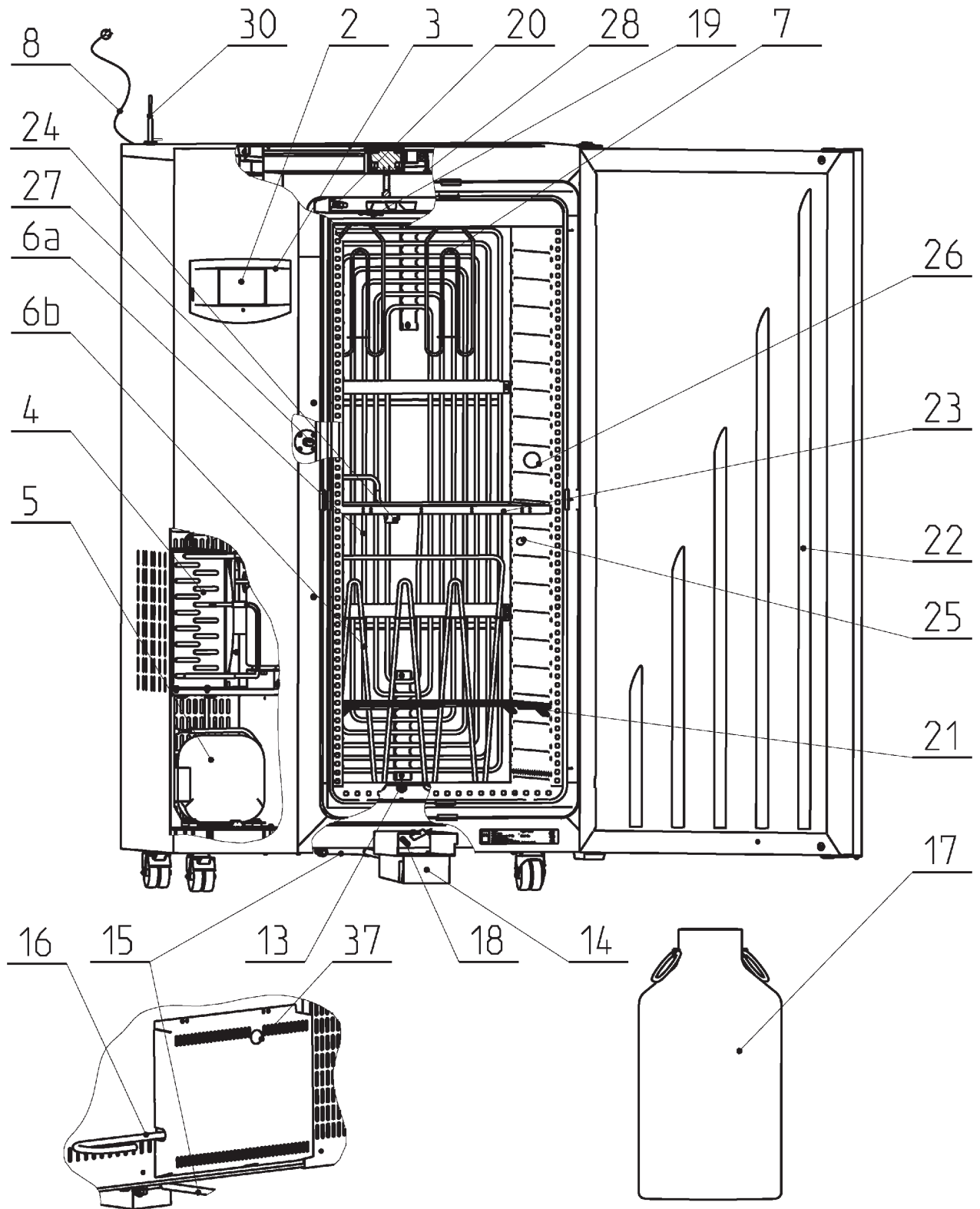

Fig. 2

3.3 COMMUNICATION PANEL

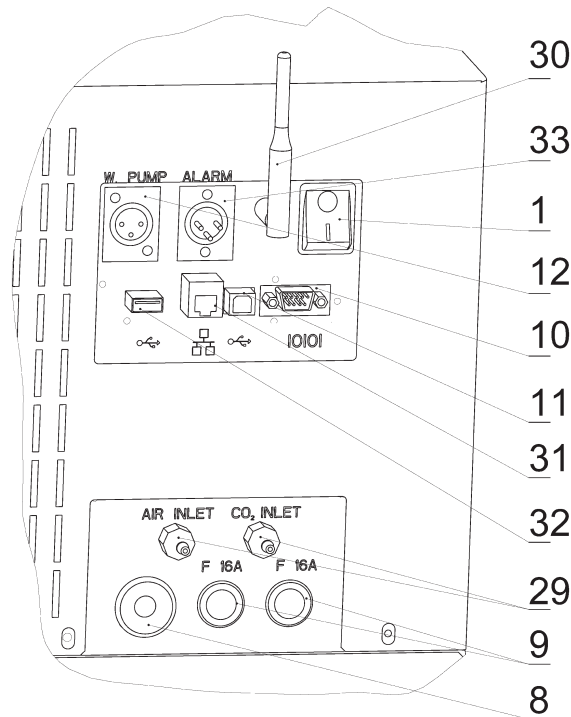

Fig. 3

Standard version

1	Network push button	12	Pump connector
2	Control touch panel	13	Input of steam from steam generator
3	Plastic cover of control panel	14	Waste vessel with pump
4	Condenser	15	Waste water discharge
5	Compressor	16	Water inlet from reservoir
6	Cooling tube evaporator - 6a - cooling, 6b - freezing (RH regulation)	17	Distilled water reservoir
7	Heating bodies in heating space	18	Outlet of waste water from chamber and door to the vessel
8	Network connection	19	Temperature sensor PT 100
9	Fuses T16A/1500	20	Relative humidity sensor
10	Connector RS232	21	Screens (2 pcs)
11	Connector USB device (USB B)		

Optional equipment

22	Exposition lighting in the door (LED, fluorescent lamps)	29	Inlet of CO ₂ (gas) and air (external)
23	Exposition lighting of racks (LED, fluorescent lamps)	30	Wifi antenna
24	Lighting sensor (VIS or UV)	31	LAN connector
25	Placement inside of switched socket	32	Connector USB HOST
26	Placement of inner bushing	33	Potential-free contact
27	Sensor of CO ₂ (gas)	37	Outlet of steam from pressure safety lock
28	Inlet of CO ₂ (gas) to the chamber (internal)		

3.4 CONTROL PANEL

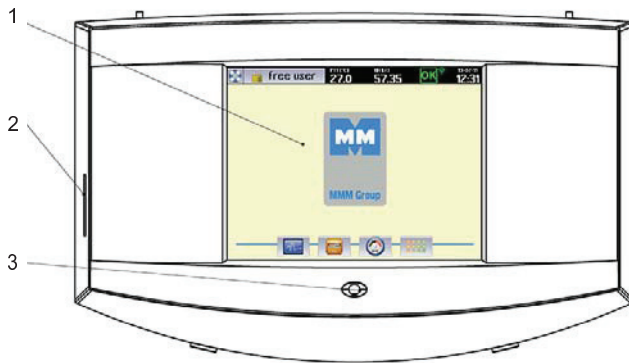

Fig. 4

- (1) Control touch panel
- (2) SD card
- (3) Indication LED

3.5 USEFUL SPACE

Useful space is displayed in Fig. 5. In the space delimited with thick lines in the figure there are fulfilled (in connection with standard DIN 12 880) the temperature variations as specified in chapter 11. The thin lines demark inner walls of the chamber. That means that above the last upper screen, the values from this chapter are not binding any more.

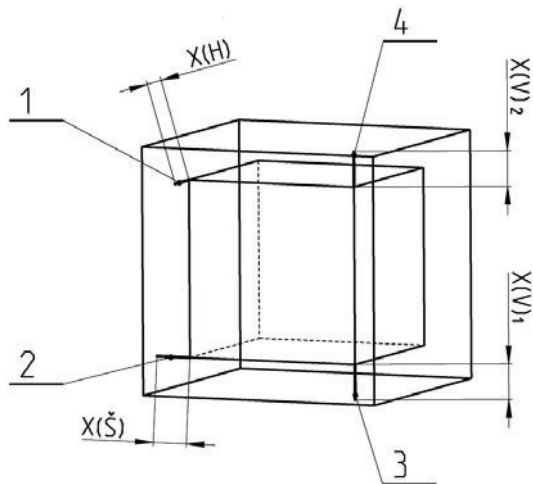

Fig. 5

- (1) X(H) – 10 % of inner chamber depth
- (2) X(Š) – 10 % of inner chamber width
- (3) X(V)1 – distance of the lowest screen (rack) from the bottom of the inner chamber
- (4) X(V)2 – distance of the top screen (rack) from the ceiling of the inner chamber

4 TECHNICAL DATA I

4.1 GENERAL DATA

Name CLIMACELL E			111 / 111-c	222 / 222-c	404 / 404-c	707 / 707-c	1212 / 1212-c	
Inner space of the chamber, stainless steel DIN 1.4301 (AISI 304)	Volume	approx. litre	110	219	404	704	1408	
	Width	mm	540	540	540	940	3x540 (1905)	
	Height	mm	535	765	1415	1415	1415	
	Depth	mm	380	530	530	530	530	
Steam space volume		approx. litre	167	305	530	878	1753	
Outer dimensions (including door, handrail and wheels)	Width	mm	780	780	1100	1500	2530	
	Height	mm	1215	1450	1880	1880	1915	
	Depth	mm	755	885	885	885	885	
Dimensions with package (three-layer cartoon)	Width	mm	850	850	1170	1570	2600	
	Height (including palette)	mm	1360	1630	2070	2070	2105	
	Depth	mm	840	980	950	950	950	
Weight	net	kg	110/120	/153	240/250	280/290		
	gross	kg	140/150	/172	280/290	326/336		
Screens of stainless steel *)	Lead for screens	max. No.	7	10	19	19	3x 19	
	Standard equipment	pc	2				6	
	Pitch between screens	mm	70					
Maximal load	Screen	kg/screen	20	30	30	50	30	
	Sheet rack	kg/rack	20	30	30	20	30	
	In total	kg/case	50	70	100	130	300	
Number of doors	External - metal/ internal - glass	pc	1 / 1	1 / 1	1 / 1	2 / 2	3/3	
	Min. distance of the device from the walls and objects	Rear and side walls	mm					200
		Upper wall	mm					400
Steam generator connection	It is prohibited to use tap water!							
Demi water	Usual	µS/cm						< 8
	Recommended	µS/cm						< 3
Pressure from the distribution system for central distribution		bar						≤ 0,5
Water cask volume		litres	20	20	50	50	50	
Min. height of water level in cask		mm						25
Max. pumping height of waste water		mm						1150
Pump cable length		mm						4000
Suction hose length		mm						4000
Waste hose length		mm						4000

4.2 ELECTRIC INSTALLATION AND OTHER CONDITIONS

Electric installation and other conditions		111 / 111-c	222 / 222-c	404 / 404-c	707 / 707-c	1212 / 1212-c
Voltage system	standard	1x 230V/ 50(60) Hz				
	opce	1x 115V/ 50(60) Hz				
Network voltage oscillation	%	± 10				
Class of protection against dangerous touch		I				
Separation of external circuits		Double insulation				
Device for type		standard CEE-7/VII, IEC-83/CH, 16 A/250 V (or other depending on version)				
Intake cable length	mm	3000				
Socket protection	A	min. 16				
Coverage according to EN 60529		IP 20				
Overvoltage category according to (IEC 664 – EN 61010)		II with pollution 2				
Fuses on rear wall of the superstructure (extension)		Safety fuse T 16A/1500				
Max. input of the device **)	W	2050/1630	2100/1780	3150/2115	3400/2640	xx/3215

Heat losses at 37 °C	ca W	70	63	123	148	200
Complete device noise level	dB	46	50/56	56/58	58	60
Operation conditions	Let the installed device stand still in operation position for 2 hours before its first put into operation!					
Ambient temperature	°C	+5 up to +40				
Max. relative humidity at 31 °C	% RH	80				
Max. height above sea level	m n. m.	3000				

All the data apply in empty chamber (without samples on screens) for ambient temperature of 20 - 22 °C, 100 % fan revolutions, feeding voltage 230 V ± 10 %.

- *) The screens may be filled in approximately 50 % of surface and if possible in such a way so as there is allowed equal air flow inside of the chamber space.
- ***) Compressor + condenser + electromagnetic valves + fan(s) + steam generator heating.

4.3 COMMUNICATION INTERFACE

- Ethernet: 10/100 Mbps interface 1 x RJ45 standard IEEE 802.3u half/full duplex
- Wifi: IEEE 802.11b, IEEE 802.11g
Frequency:
Europe: 2.412-2.472GHz
USA: 2.412-2.462GHz
Japan: 2.412-2.484GHz
Channels:
Europe: 13 channels
USA: 11 channels
Japan: 14 channels
- USB host: USB 2.0, full speed
- USB device: USB 2.0, full speed
- SD/MMC card: max. capacity 32 GB
- RS232:
- Printer connection:
Baud: 9600
Stopbit: 1
Parity: none
Databit: 8

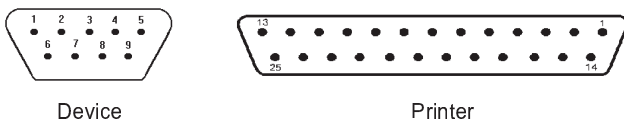

Fig. 6

9 pin Canon connector on box DE9 Male

Pin	Signal
2	RXD
3	TXD
4	DTR
5	GND
6	DSR

25 Canon connector on printer DB25 Female

Pin	Signal
2	TXD
3	RXD
7	GND
20	DTR

Note:

Ethernet, Wifi and USB Host are available only with devices with communication module, see chapter 6.15.

5 BASIC EQUIPMENT

The standard supply includes:

- incubator,
- two screens,
- filling system (order No. S211567 or S211568),
- waste system (order No. S211558),
- handling hooks (only size 404 and 707),
- instructions for incubator use,
- SD card.

6 ADDITIONAL EQUIPMENT

6.1 INTERNAL LIGHTING

The lights are placed inside of the chamber on the left. Heat-resistant bulbs are used. The light switch is placed on the door. In combination with the door window there is always a light placed in the door.

6.2 BUSHINGS WITH DIAMETER 25, 50, 100 MM

Standard placement of bushings can be found approximately in the centre of the side (left or right) wall of the chamber. The bushings are made of metal, they are closed from the outer side with a special plastic plug allowing lacing the conductors etc. from the outer space to the chamber space.

Recommendation: the device used should be equipped with a dimension-corresponding bushing in case that the user wants to measure one of the items (T, RH, CO₂, etc.) with sensors connected with the external independent measuring device by conductors; the user pulls the conductors through the bushing. So as to reach the correct functioning of the incubator, the conductors, hoses, etc. pulled through the bushing must be hermetically sealed in the bushing.

6.3 MECHANIC LOCK OF THE DOOR

The lock is placed on the upper front surface of the door close to the locking mechanism.

6.4 ELECTRIC LOCKING (BLOCKING) OF THE DOOR

In the course of the material exposition, the door is blocked by an electromagnetic mechanism so as to avoid undesirable opening.

6.5 DOOR HINGED ON THE LEFT

This is a mirror-like symmetrical version of the door hinged on the right. Cases with volumes of 404, 707 and 1212 litres are not supplied in left version.

6.6 INDEPENDENT SENSOR PT 100

The independent movable sensor is used for measuring the material temperature directly in the chamber. It is possible to connect as many as four sensors.

The data on temperature of the sensors are displayed in system information, see chapter 8.6.

When printing on the printer, each record consists of a few lines, the first line starting with number 1 shows the temperature on the regulator sensor, the other lines starting with letters display the temperature on movable sensors.

6.7 COMMUNICATION SW (WARMCOMM 4) FOR PC WITH WINDOWS

The program WarmComm is designed for recording of the temperature regulation course in temperature cases. The data obtained in the course of regulation are displayed in the form of a graph. The program allows monitoring of regulation in real time, saving of the regulation progress in a file, watching formerly created files, sending e-mails in case of non-receiving data from the case and sending reports on extreme values reached in a set time interval.

Instructions for use of the program are supplied together with the installation program. The hardware requirements can be managed by a standard PC with operation system Windows XP or higher.

6.8 POTENTIAL – FREE CONTACT FOR ALARM REPORTS

It is taken out to the connector (33), Fig. 3, in the rear part of the device. Maximal load of the contact: 24V/1A..

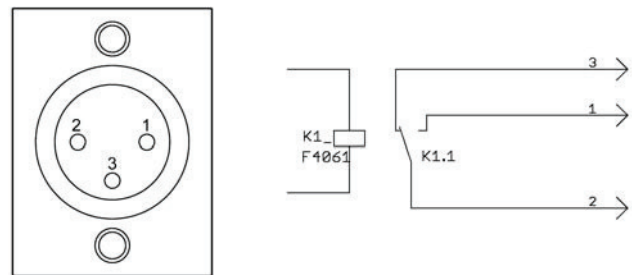

Fig. 7

6.9 INNER SWITCHED SOCKET

The socket (nominal voltage 230V, fuse 3 A, coverage IP67) is located inside of the chamber on the side wall. For details on switching control see chapter 8.4.3.

Connection of the connector and the built-in device

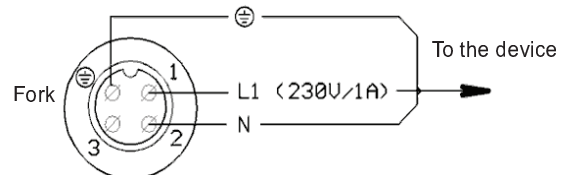

Fig. 8



The fork may be connected only by a person with relevant electro technical qualification. When inserting the fork to the socket and pulling the socket out of the socket or when handling the inner equipment, it is necessary for the device to be switched off (network switch in the off position).

– „0“). The connection socket – fork must be appropriately tightened so as not to decrease the declared degree of protection (IP 67). After disconnection of the fork and the socket carefully screw the protection covers on the socket and the fork so as impurities and humidity cannot penetrate into them.

Note:

In this version, the maximal operation temperature of the device is limited to 60 °C.

6.10 EXPOSITION LIGHTING

6.10.1 EXPOSITION LIGHTING IN DOORS

The exposition fluorescent or LED lighting is placed in the door. Its intensity is controlled from 0 % to 100 % in steps of 10 %, see chapter 8.4.4.

6.10.2 EXPOSITION LIGHTING ON RACKS

The chamber may house racks with exposition fluorescent or LED lighting, its intensity is controlled from 0 % to 100 % in steps of 10 %, see chapter 8.4.4.

6.11 SENSORS FOR MEASURING THE INTENSITY OF UV AND VIS EXPOSITION LIGHT IN THE CHAMBER

The measured values may be displayed on the display and they are saved in the program protocol. Both types of sensors may be simultaneously used in one device (six sensors as a maximum).

Notes:

Sensors for measuring the intensity of UV and VIS light have the range of operation temperature from -20 °C to 80 °C. So as to avoid their damage, the temperature in the chamber is limited as follows:

- o maximal operation temperature of the device is limited to 75 °C,
- o in case of the temperature in the chamber to reach 80 °C, all the heating elements and exposition lighting is switched off and an alarm is announced.

6.12 TEMPERATURE RANGE FROM -20 °C

The RH is not regulated in the temperature range from -20 °C to +10 °C.

This version cannot be combined with exposition lighting on the door (in switched on and off status) and on the racks (in switched on status).

6.13 CHAMBER DE-CONTAMINATION

The chamber is heated to 160 °C and the temperature is kept for specified time period. Everything is controlled by the given program and it is not possible to change the values.

6.14 REGULATION OF CO₂ CONCENTRATION

Using the regulation system and the CO₂ sensor it is possible to correct and measure the CO₂ concentration in the chamber. Allowed temperature range is from -20 °C to 60 °C, the humidity is not limited, but water must not condensate on the sensor. The range of CO₂ concentration is from 0 to 20 % or 0-2000 ppm respectively it may also be different – it depends on the CO₂ sensor type used and on device configuration by the manufacturer.

6.15 COMMUNICATION MODULE WITH ETHERNET, WIFI, USB HOST

- The communication module allows connection of the device to local network using LAN connector or Wifi.
- It provides an active web server accessible via LAN. The web server allows remote monitoring of current regulation progress on the device, viewing the history of protocols and audit trail.
- It is possible to use the communication module for sending e-mails in case of error status occurrence or in case of any warning.
- It provides the user with communication interface USB host, via which it is possible to connect USB flash disk respectively some other large capacity memory device doer data saving.

6.16 PRINTER DPT- 6333

The thermo printer connectible via RS232, paper width 58 mm, is supplied with a cable and feeding source.

6.17 ANDROID APPLICATION FOR DEVICE STATUS MONITORING

The CLC Monitor application is designed for monitoring of device activity at mobile devices with operation system Android. The application provides the user with information on current status of remote device within the reach of WIFI.

7 PUTTING THE DEVICE INTO OPERATION

7.1 UNPACKING AND CONTROL

After unpacking please check whether the device and its accessories are complete and undamaged.

Any possible damage must be immediately reported to the carrier! Do not lift up the case for the handrail or door in the course of handling (e.g. case lifting, etc.). Lift the case up using the enclosed hooks. When removing the case from the palette take care of the device bottom. Lift the case up using the hooks and move the palette completely out. Then put the case carefully on the wheels designed for local movements on smooth floor – not for any prolonged transport. Pay attention mainly to door steps and entries to lifts. In such cases it is also necessary to lift the case up using the hooks. In the course of any handling of the case, the door must be closed and the case must be disconnected from power mains. When moving the case be always very careful and handle the case in such a way so as not tip it over. In case of sizes 404, 707 and 1212 it is necessary to protect the case against possible tipping over by fastening it to the wall see chapter 7.3.

7.2 IMPORTANT WARNINGS

CLIMACELL is designed and manufactured in compliance with requirements of EU regulations No. 2006/95/EC and 2004/108/EC and it is individually tested according to EN 61010-1.

Let the installed device stand still in operation position for at least two hours before putting it into operation for the first time.



Read these Instructions for Use carefully before starting the use of the device!



The load capacity of the floor for the device placement must correspond with the weight of the device, taking into consideration the maximal charge weight (see chapter 4.1).



It is not allowed to place the device on a mat that may cause a risk of fire or smouldering in case of hot objects to fall out of the device.



It is not allowed to insert any flammable, explosive or poisonous substances or materials that could release such substances to the device!



The devices are not designed for environment with risk of flammable or explosive substances (e.g. anaesthetics).



If the device is used with CO₂, it is necessary to protect the premises in case of excessive gas leakage (well ventilated room, sensors of CO₂ with alarm, etc.).



Any assemblage or disassembly of parts of the device may only be performed after the device disconnection from electric network by pulling the feeding cable from the socket!



In case of temperatures below 0 °C or above 60 °C there is a risk of injury caused by metal handles on inner glass doors. Use protective aids.



When operating a device with pre-set temperature above 70 °C be extremely careful when opening the door. As the pre-set RH is kept, hot steam develops in the chamber and it may cause scalding.



The protection of the temperature case, its surroundings and processed material against prohibited temperature exceeding is arranged by a protective thermostat according to EN 61010-2-010.



The network connection must not get in touch with hot parts of the device.



You can find all and any installation conditions of the device in tables, see chapter 4.



The cases stand on the floor, they are space saving, equipped with castor wheels. It is necessary for the cooling incubator to stand on flat floor (because of the device functionality). And we recommend a waste canal to be located in the room for any case of water leakage.



After the device placement to the desired location, turn and set the brake of the castor wheels. The front one in the front direction and the rear ones in the rear direction, in parallel with sides of the device in such a way so as the device gets maximal possible stability in forward and backward directions.“



Always place the material on screens in the device, never put it on the bottom of the device!



If you want to start the chamber decontamination, it must be empty (only the RH sensor may stay).



It is not possible to start decontamination in devices with a window in the door.



The temperature and RH regulation is negatively affected by reduction of fan speed, exposition lighting and measuring of CO₂. There do not apply the values from chapter 11.1.



The RH regulation is also negatively affected in case of any other humidity source but the generator to be in the chamber.



If you use the device for long-term several days lasting tests at low temperatures, the ice in the chamber will grow up similarly to a refrigerator or a freezer.



Devices connected via communication interface must meet valid regulations from the point of view of electrical safety and electromagnetic compatibility.



If you do not use the incubator for prolonged time, disconnect it from the network by pulling the feeding cable form the socket.



In case of the device to be used in any other but designed way, the protection provided by the device may be affected.

7.3 DEVICE PLACEMENT

Cases with volumes of 404, 707 and 1212 l must be fixed to the wall in the room using the enclosed fixation set. Place the device to the required location and mark the place for drilling a hole in the wall. Drill the hole according to the wall plug used. The wall plug supplied is designed for ordinary bricks – in case of any special bricks it is necessary to use corresponding wall plug type.

- Drill a hole to a fixed wall and place the wall plug into it (5).
- Fix the fixation set (1), (2), (3) on the device.
- Fasten the device to the wall using the enclosed screw (4).

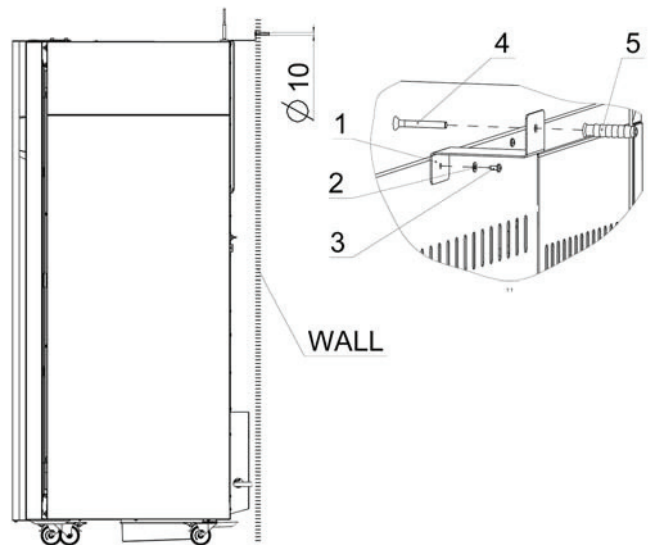

Fig. 9

7.4 CONNECTION TO WATER SOURCE AND WASTE

The device may be connected to the cask supplied by us or to water distribution system. In both case, the water and water mains must meet the parameters as per chapter 4.1.

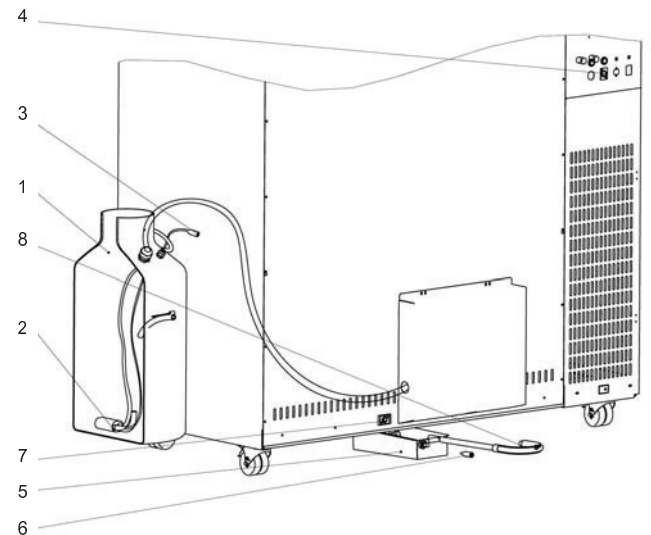

Fig. 10

- Take the cask (1) out of the chamber.
- Connect the cable connector (3) to the socket (4) back on the superstructure, see chapter 3.3.
- The waste vessel (5) is placed in the chamber. After unpacking, insert it to the holder above the device. Connect the cable connector (6) to the socket (7). Connect the free end of the waste hose (8) to the discharge.

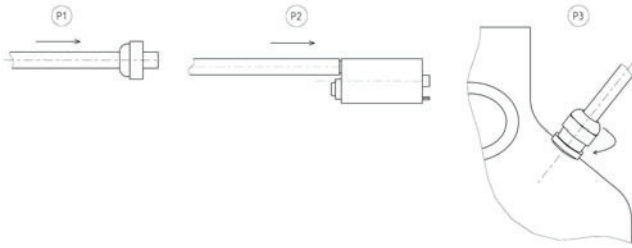

Fig. 11

- d) Pull the hose from the generator (P1) through the bushing in the cask and apply the submersible pump (2), (P2). Then tighten the bushing in such a way so as the hose (P3) is sealed.
- e) Fill the cask with distilled water and the device is ready for operation.

Note:

It is not allowed to prevent flow of let-in and let-out water in hoses.

7.5 CONNECTION TO DISTRIBUTION NETWORK

Compare the nominal voltage and device input values as specified in the production plate of the device with the voltage intake. If the intake parameters correspond with the device parameters, connect the fork of the device to the intake socket.

8 DEVICE STAFF

8.1 DEVICE SWITCH-ON

After switching the network switch (1), Fig. 3, to position „I“ the display of the control panel displays the basic menu of the device. The indication LED (3), Fig. 4 lights green.

8.2 BASIC MENU

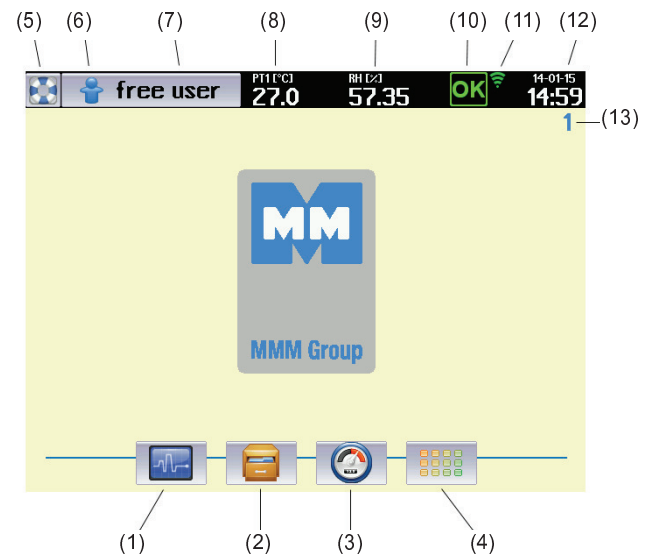



Fig. 12

- (1) Programs (8.4).
- (2) Protocol history (8.5).
- (3) System information (8.6).
- (4) Device user menu (8.3).
- (5) Help.
- (6) User login icon (8.3.2).
- (7) Name of logged-in user
- (8) Current temperature in the working part of the device.
- (9) Current relative humidity (RH) in the working part of the device.
- (10) Warning and error indication (8.3.3.1).
- (11) Device status information (8.4.7).
- (12) Current date and time.
- (13) Device identification number (8.3.7).

8.3 DEVICE USER MENU



In order for the device to be operated precisely as the user requires, it must first be set up. Click  (Fig. 12) to open the device settings screen.

Note:

Only colour-highlighted icons may be used for user settings; the grey icons are inactive (only accessible by the administrator).

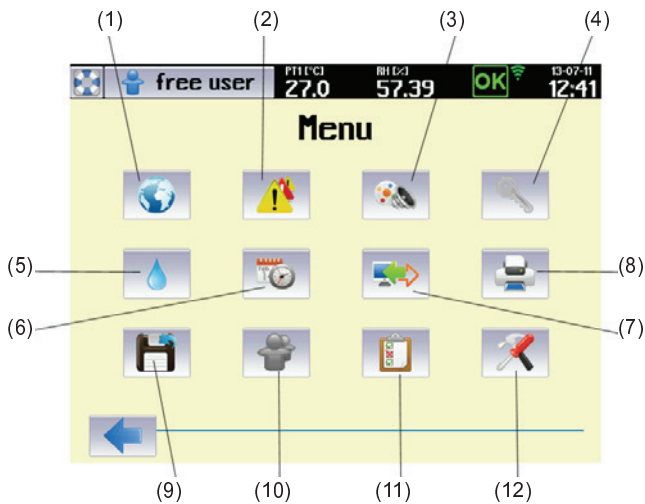

Fig. 13

- (1) Selection of national environment (8.3.1)
- (2) Error and report history (8.3.3.2)
- (3) Display and sounds (8.3.4)
- (4) User administration (8.3.2)
- (5) Device maintenance (8.3.5)
- (6) Date and time (8.3.6)
- (7) Communication (8.3.7)
- (8) Print (8.3.8)
- (9) Backup (8.3.9)
- (10) User administration (8.3.2)
- (11) System tests (8.3.11)
- (12) Service and system settings (8.3.10).

8.3.1 NATIONAL ENVIRONMENT



By clicking on the icon (Fig. 13) you will open the menu for national environment selection.



Fig. 14

8.3.2 USER ADMINISTRATION



The device controls can be accessed in two different modes:

- Without user administration
See 8.3.2.1.
- With advanced user administration
See 8.3.2.2.

8.3.2.1 WITHOUT USER ADMINISTRATION MODE

This mode is the factory default setting. The user has access to all the device's menus with the exception of special service functions. This mode is particularly suitable for users who do not require the device to be secured against unauthorised access. It is not necessary to log in to control the device.

The without user administration mode recognises two different types of users:

- **Free user:**
 - User with unrestricted access to the device controls (except for special service functions).
 - The field (7), Fig. 12, displays the words free user.
- **Administrator:**
 - May activate (deactivate) advanced user administration, see 8.3.2.2.
 - The field (7), Fig. 12 displays the word admin.

8.3.2.2 ADVANCED USER ADMINISTRATION

Allows the user structure to be defined with different rights for access to controls and device settings.

Advanced user administration mode recognises three different types of users:

- **Administrator:**
 - Activates (deactivates) advanced user administration.
 - Defines individual operator-type users, allocates them access rights and passwords and places them into groups.
 - Has access to all device settings except for service functions.
 - Access the device using his username and password
 - The field (7), Fig. 12, displays the word admin.
- **Operator:**
 - User with limited access rights, subordinate to the administrator.
 - Is allocated a username and password which are used whenever operating the device

- Operator-type users may be placed into four groups, depending on their rights, see 8.3.2.2.1.
- The field (7), Fig. 12, displays the operator name.

• **Without login:**

- No user is logged into the device.
- The device cannot be operated.
- There is allowed only viewing of program protocols and viewing of status information, see 8.6.
- The field (7), Fig. 12, displays the word login.

8.3.2.2.1 ACTIVATING ADVANCED USER ADMINISTRATION



Only the administrator has access to advanced user

administration. Clicking the  (Fig. 12) icon opens the login screen.

Factory default first time login details:

Name: admin

Password: password

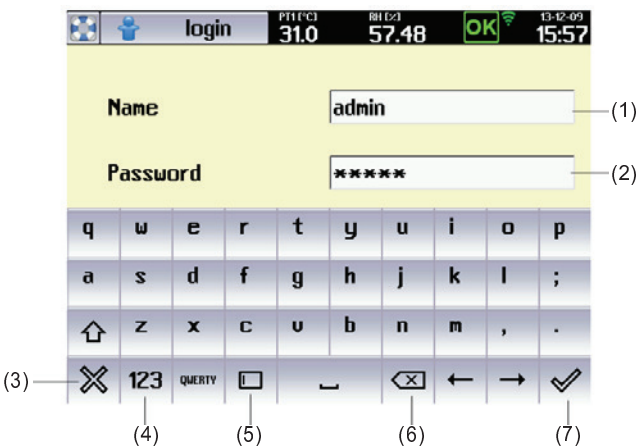

Fig. 15

- Username.
- User password.
- Cancel.
- Numerical keyboard.
- Clear button
 - Inserts a blank character.
- Delete.
- Confirm.

Select advanced user administration after logging in in the



user menu :

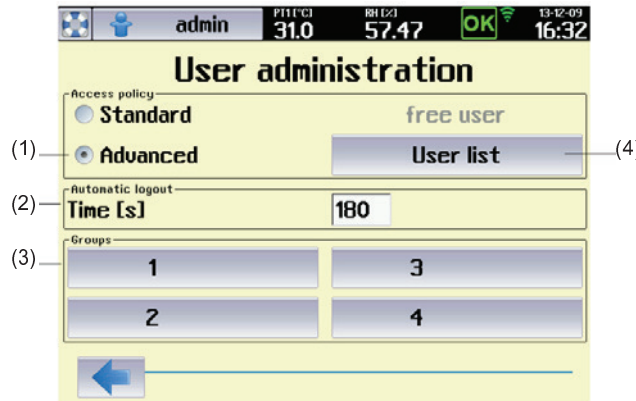

Fig. 16

- Selection of user administration mode.
- Automatic logout time.
 - If inactive for longer than the set time, the user will be automatically logged out.
 - Entering a time of 0 will cancel the automatic logout time.
- Definition of groups.
 - The administrator may place operators in up to four groups with different user rights, see Fig. 17
- Definition of users.
 - This button displays a list of all users. See Fig. 18. Login names and passwords may then be allocated for individual users (Fig. 19).

Definition of group, See (3), Fig. 16.

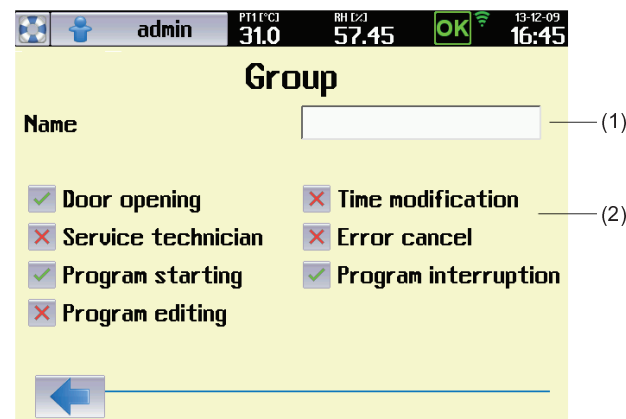

Fig. 17

- Group name.
 - Maximum permissible length of group name is 0 – 10 characters.
- Definition of group access rights.

User editing. See (4), Fig. 16.



Fig. 18

- (1) Button for defining administrator password.
 - The first button in the list is reserved for the administrator.
- (2) Buttons for defining operator names and passwords.
 - Buttons 2 – 100 are used to define operator login names and passwords. See Fig. 19.

User editing. See (2), Fig. 18.

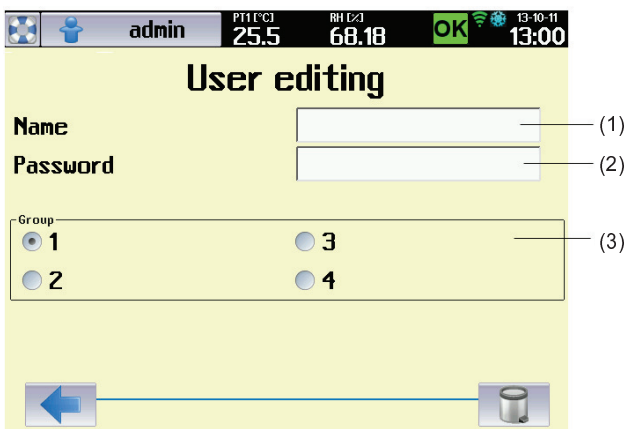



Fig. 19

- (1) Operator name
 - Maximum permissible length of name is 1 – 10 characters
- (2) Operator password.
 - Maximum permissible length of name is 1 – 14 characters.
- (3) Allocating operator to group
 - See Fig. 16, Fig. 17.

8.3.2.2.2 CHANGING USER PASSWORD



Under the  icon the user (administrator or operator) can change his access password.

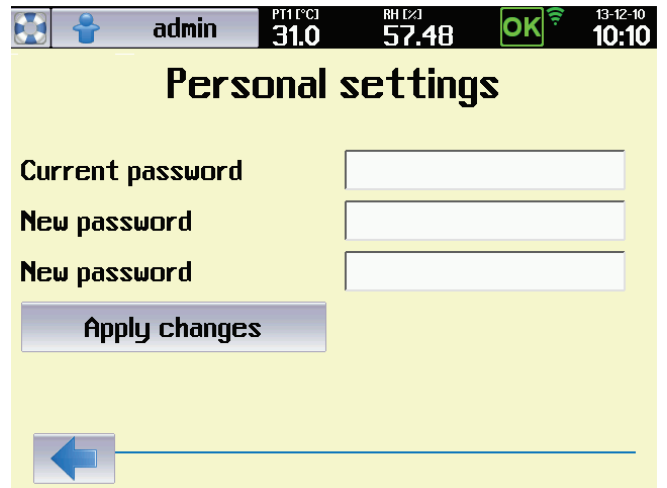
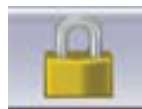



Fig. 20

Note:
Maximum permissible length of password is 5 – 14 characters.

8.3.2.2.3 LOGGING OUT



If the user is logged in and clicks  a logout request will be displayed.

8.3.3 WARNINGS AND ERRORS

8.3.3.1 CURRENT ERROR MESSAGES



CLIMACELL EVO automatically monitors a series of parameters that are important for the program to run properly and safely. If a fault or hazardous situation is detected, the user is given a visual (or audible) notification – all faults detected are displayed in the form of a list (list of current error messages, Fig. 21). This list shows all warnings or errors whose cause has not yet been rectified.

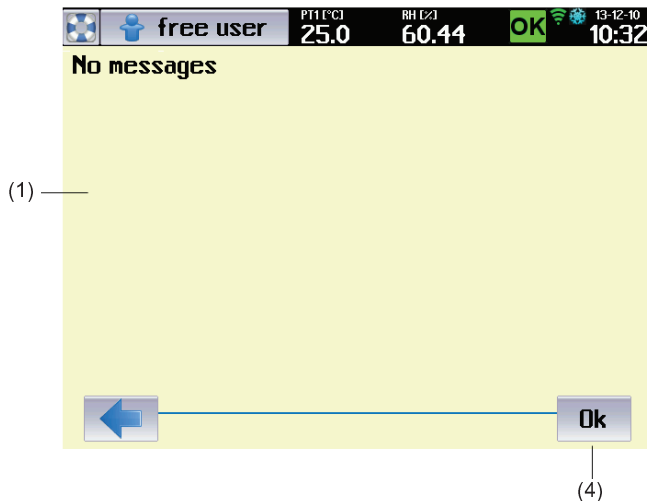

Fig. 21

- (1) Current error messages.
- (2) Button for confirming all displayed errors.

The list of current error messages can also be displayed by clicking the icon (10), Fig. 12; the icon can have the following meanings:



No error messages - program is not running.

- ED signal light is green (3), (Fig. 4).



No error messages - program is running.

- LED signal light is green.



Warning.

- The flashing symbol is displayed if a non-critical fault occurs, i.e. a fault which does not prevent the program from running. After pressing OK to confirm, the symbol will stop flashing, although it remains on the toolbar if the fault is still present.

- The LED signal light acts the same as the symbol – it flashes (lights up) orange.



Error.

- The flashing symbol warns the user that a serious fault has occurred while the program is running. Upon this kind of error the program is stopped and the system awaits confirmation from the user. After pressing

Ok

, the symbol will stop flashing, although it remains on the toolbar if the fault is still present. The program may only be restarted once the cause of the error has been rectified. These errors are displayed in red in the list.

- The LED signal light flashes (lights up) red.

8.3.3.2 HISTORY OF FAULTS

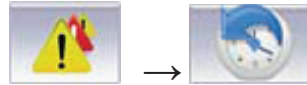

After fault elimination and after confirmation by push button

Ok

the fault is transferred to the history of faults (Fig. 22). You can display the history of faults by pressing



in the menu for device setting (Fig. 13). The list displays last thirty fault events.

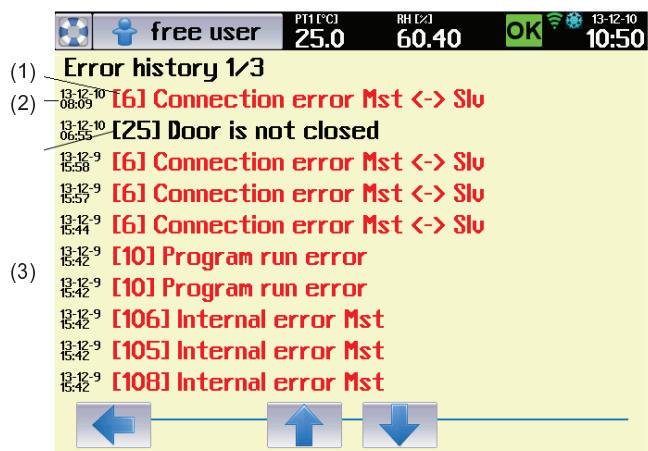



Fig. 22

- (1) Fault occurrence record ().
- (2) Date and time of occurrence
- (3) Warning occurrence record ().

8.3.4 DISPLAY AND SOUNDS



By clicking on icon (Fig. 13), you will display the menu for setting the display appearance and selections for sound signals.

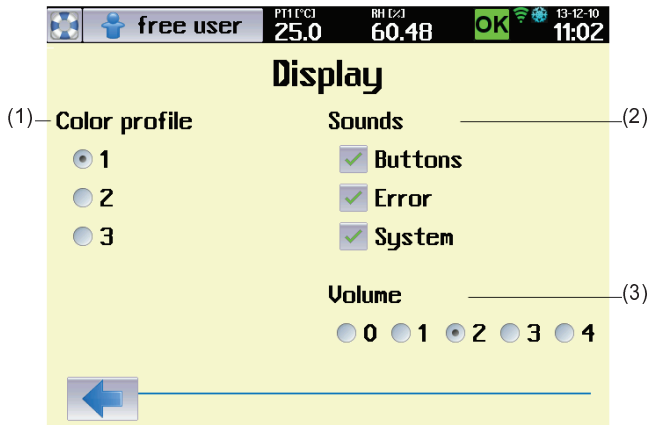

Fig. 23

- (1) Colour profile setting.
- (2) Volume level setting.
- (3) Acoustic indication options.

8.3.5 DEVICE MAINTENANCE MENU

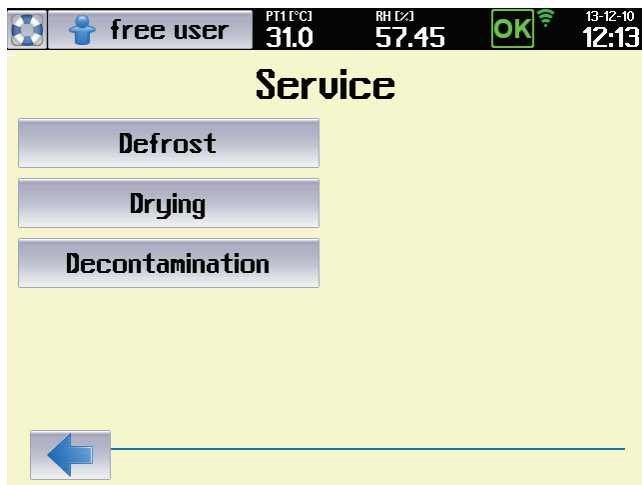

Fig. 24

8.3.5.1 SINGLE DEFROSTING



→ Defrosting

It is suitable to use single defrosting mainly in programs with long-term intensive cooling, when the condensate gets frostbitten in the chamber and on the cooling system of the device. In the course of single defrosting, the frost is efficiently removed. The operation cannot be activated when

the program is running. Defrosting is activated in the device maintenance menu.



Warning:

In case of single defrosting the temperature in the chamber of the device increases to 50 °C, so take the tested samples out of the incubator so as to avoid their damage.

Note:

It is necessary to distinguish between automatic defrosting of cooling system (see 8.4.3) and single defrosting of the whole device. Automatic defrosting removes icing from the cooling system of the device only (and so it increases its efficiency) and it is performed automatically in the course of the program operation. Single defrosting removes icing from the whole device and it cannot be run while the program is running.

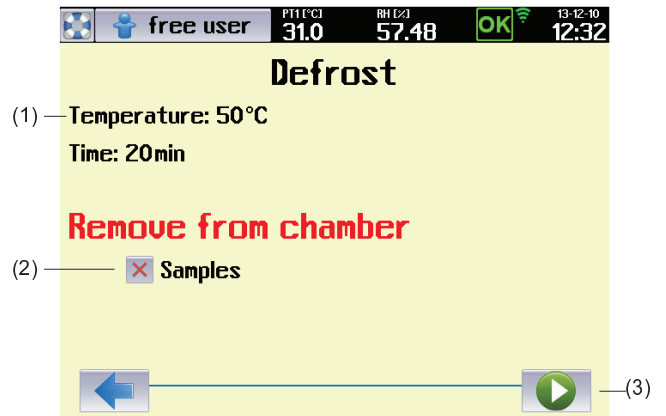

Fig. 25

- (1) Defrosting program parameters.
- (2) Warning regarding objects that must be taken out of the device.
 - This option must be ticked, otherwise it is not possible to start the program.
- (3) Defrosting program start.

8.3.5.2 DECONTAMINATION



→ Decontamination

In the course of decontamination, the operation space of the chamber faces high temperature. The initial parameters for exposition are 160 °C and 30 minutes. These values may be adjusted according to client's requirements (a service intervention is necessary).

Notes:

- Decontamination is not possible in some versions of the device as the high temperature could damage some parts of the device and that is why it is factory blocked.
- Decontamination is blocked for the version with exposition lighting.



Warning:

Before start of the decontamination program it is absolutely necessary to take out of the device all and any objects and accessories that could be damaged or destroyed by high temperature influence!

These include mainly:

- tested samples
- racks with exposition lighting
- lighting intensity sensors
- CO₂ sensor.

After selection of decontamination (Fig. 24) there will be displayed a menu for the decontamination program start:

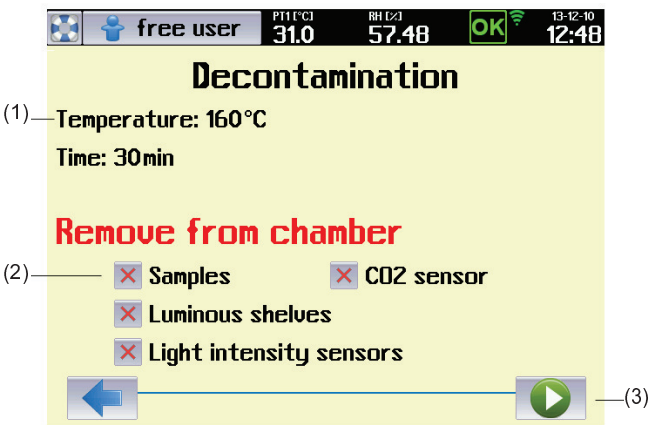

Fig. 26

- (1) Decontamination program parameters.
- (2) Warning regarding objects that must be taken out of the device.
- (3) Decontamination program start.

Note:

Options (1), (2) must be ticked, otherwise it is not possible to start the program..

8.3.5.3 DRYING



→ Drying

Drying removes in an optimal way all and any residuals of condensed humidity from the chamber of the device.

- In the course of drying, the fan revolutions are set to 100 % and temperature in the chamber is kept around 40 °C. Before start of drying it is necessary to take out of the device all and any material that could be damaged by the above stated temperature.

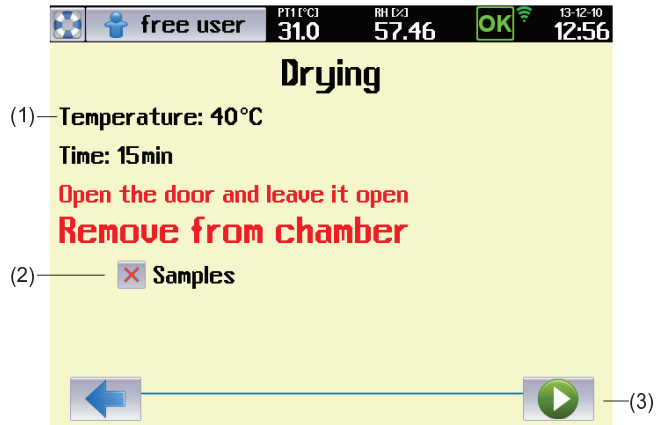

Fig. 27

- (1) Drying parameters.
- (2) Warning of the material that must be taken out of the device.
- (3) Start of drying.

Note:

So as to reach intensive chamber ventilation it is required for the door of the device to be open before start of drying.



Fig. 28

8.3.6 CURRENT DATE AND TIME SETTING

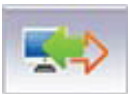



Fig. 29

- (1) Current date.
- (2) Winter time.
- (3) Time delay in hours in case of transfer to summer time.
 - Here you can easily move time to summer (winter) time. Change in this position means a change of time in upper bar. It is not possible to perform such movement when the program is running or in delayed program start mode.
- (4) Current time.

8.3.7 COMMUNICATION — ACTIVATION



In the Communication menu there is set the communication interface for the application WarmComm4, there is also performed activation of Wifi connection and e-mail account.

Note:

Selections LAN, E-mail sending of reports and Wifi are available only at devices with communication module, see 6.15.

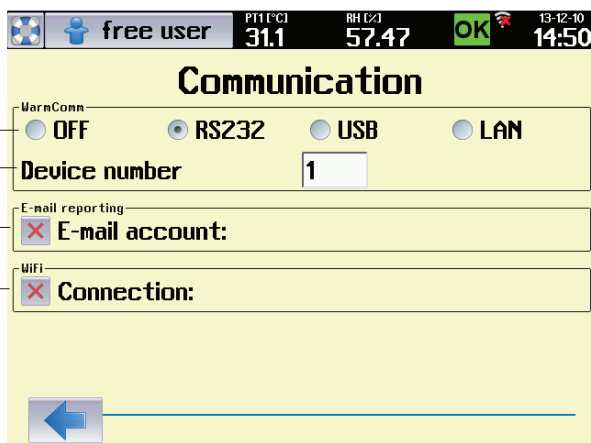

Fig. 30

- (1) Communication interface for WarmComm4
- (2) Identification number of the device
 - The number allows distinguishing of individual devices in cases when a user uses several CLIMACELL EVO devices at once.
 - Displaying the device identification number on the device display - see 8.4.7.
- (3) E-mail account activation, see 8.3.7.2.
- (4) Wifi options
 - When this option is selected, there are found access points of available WLAN.
 - A red cross means that Wifi connection is not active.

8.3.7.1 WIFI CONNECTION ACTIVATION

By clicking the push button (3), see Fig. 30, you will display a list of available access points.



Fig. 31

- (1) Example of the list of access points found.
 - In our case there was selected TechLink01 WEP64.

After selecting the access point there is required a password for access to WLAN.

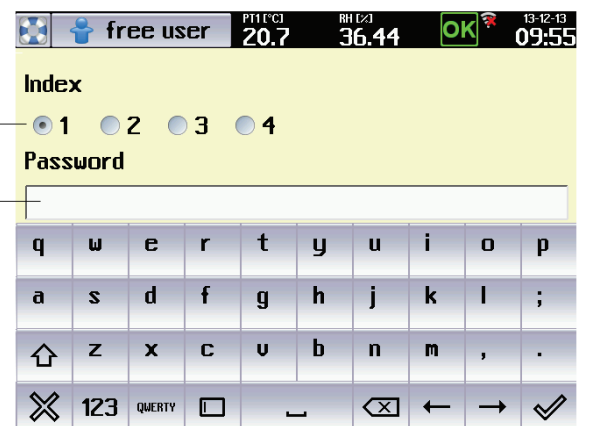

Fig. 32

- (1) Password Index.
 - The user may have as many as four passwords for access to the access point. The password index defines which of the passwords is used.
- (2) Password.
 - It is provided by WLAN administrator.

After password entering there is displayed the access point which the connection has been established with.

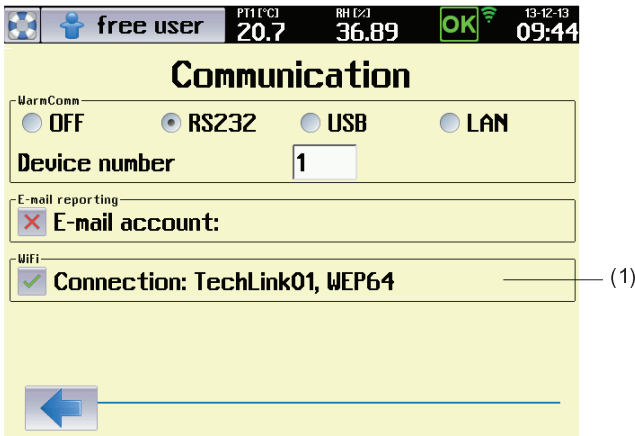

Fig. 33

- (1) Access point which the connection has been established with.

8.3.7.2 E-MAIL ACCOUNT ACTIVATION

By pushing the push button (2), Fig. 30, there will be displayed a screen for e-mail account login.

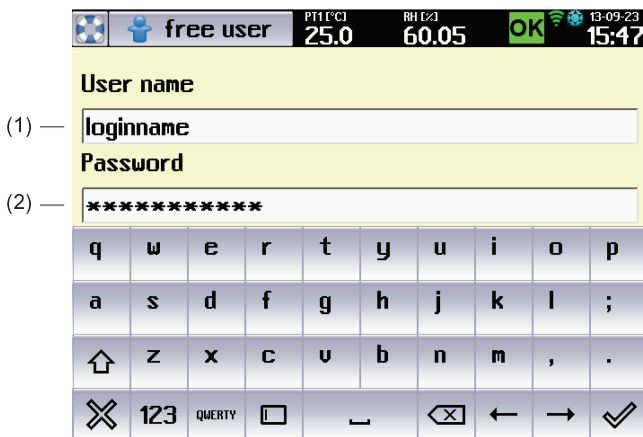

Fig. 34

- (1) Name for e-mail account login.
- (2) Password for e-mail account login.

Note:

- The proper e-mail account activation must be preceded by its creation. It is possible to create the account on any

server providing e-mail services. Contact your system administrator to create an account, respectively use services of any of public e-mail service providers (www.gmail.com, www.yahoo.com, etc).

- When creating an e-mail account, the user obtains a unique name and password for his/her account. Enter the data to positions (1) and (2), Fig. 34.
- For e-mail communication setting, see also 8.3.10.1.3.

After successful login there is a green tick in the e-mail account push button and the name of then account is displayed (Fig. 35).

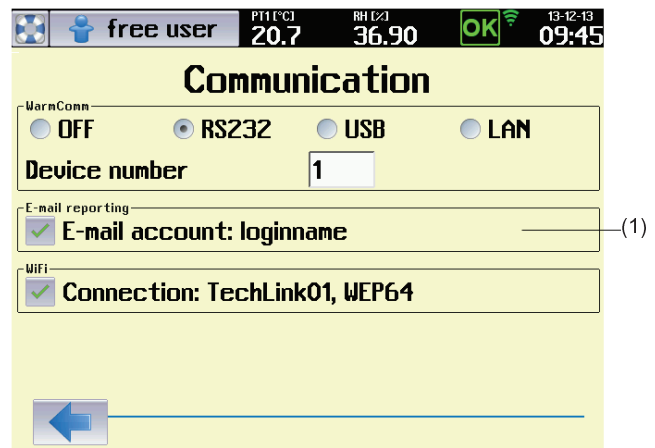



Fig. 35

- (1) E-mail account.

8.3.7.3 WIFI CONNECTION VIA INTERNET BROWSER

CLIMACELL EVO provides the possibility of remote monitoring of the device status. The wifi web server runs on communication module and it is possible to connect to it via ordinary Internet browser.

To establish connection with CLIMACELL EVO proceed as follows:

1. Connect the device to local network and configure it correctly - see 8.3.7.1 a 8.3.10.1.2.
2. From the system information panel 2/2 (Fig. 74) read the pre-set IP address for WIFI.
3. Insert the address to the address line of the web browser in PC, connected to the same local network as the device.
4. The status of the device will be read on the web site, see Fig. 36.
5. The last error message will be displayed after clicking on the icon , see Fig. 37.
6. System information will be displayed by clicking on "System Information". See Fig. 38.

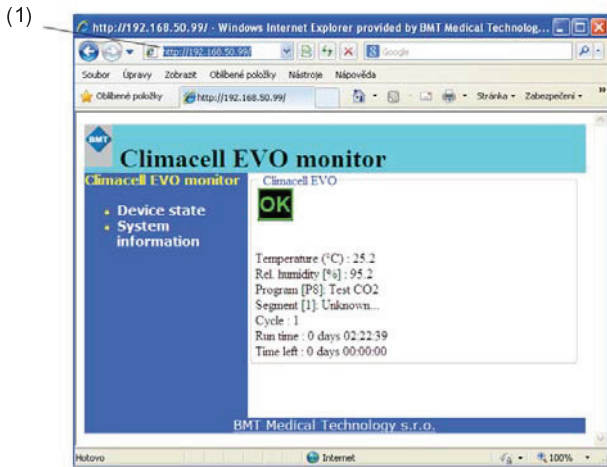

Fig. 36

(1) IP address of Wifi.

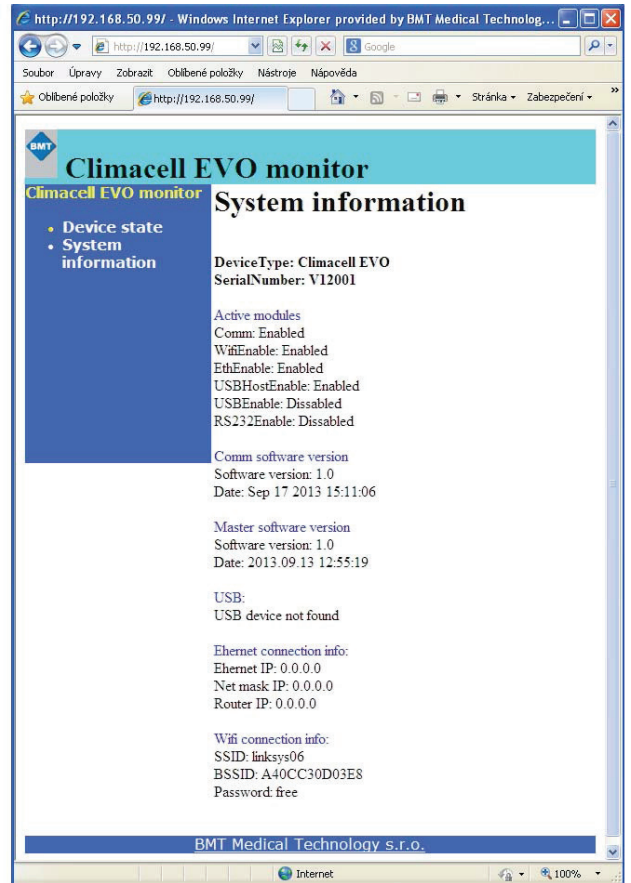

Fig. 38

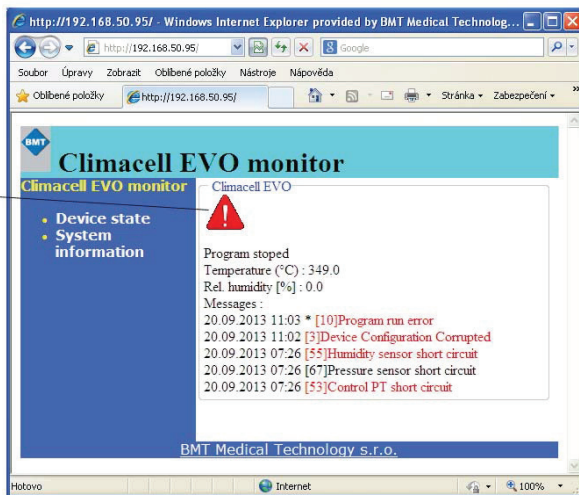

Fig. 37

(1) Icon for faults displaying.

8.3.8 PRINT



The menu is displayed using the icon (Fig. 13).

Note:

We recommend use of the printer DPT6333, see 6.16.

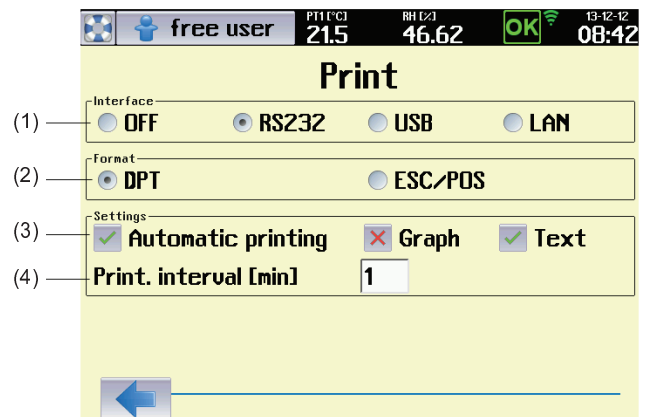

Fig. 39

- (1) Communication interface selection.
- (2) Data format supported by the printer
 - The data format is set in the technical specification of the printer. For the printer DPT6333 select „DPT“.
- (3) Options for printing.
 - Automatic printing – a protocol is automatically printed after the program termination.
 - Graph – only the graph is printed.
 - Text – only the text is printed.
- (4) Print interval.
 - It sets the printing period – it is possible to set 1 up to 999 minutes.

8.3.8.1 PROTOCOL PRINTING

Connect the printer and the device using the cable according to 4.3. The connector for RS232 can be found on the communication panel in the rear part of the device (Fig. 3).

Connect the printer to power supply and switch on the power switch (proceed according to instructions for use of the printer). The printer may receive data from the device while being in ON-LINE mode (push button SEL). Select the interface (RS232). Set the printing mode.

The printout contains:

- Printout heading:
 - o device type,
 - o serial number,
 - o batch number,
 - o program parameters,
 - o printing interval.
- Program data:
 - o program start time,
 - o values of items in given time.

Notes:

- A new heading is printed in case of program parameters change.
- In case of device feeding cut off there is printed a message after power supply restoration → Network cut off.
- Setting of DIP switches on the printer DPT-6333:
 - 1 - OFF
 - 2 - OFF
 - 3 - ON
 - 4 - OFF
 - 5 - OFF
 - 6 - OFF.

8.3.9 BACKUP



CLIMACELL EVO allows performance of backup of some important settings of the device (list of programs, list of users, device configuration). It is possible to use saved data for consequent restoration of original setting or for configuration of another device. The menu is activated by



the icon (Fig. 13). As a recording medium it is possible to use SDHC card or USB flash disc. The card is inserted to the appropriate slot on the control panel, the USB flash disc is connected via the USB Host connector in the rear part of the device.

Note:

For the USB flash disc connection the device must be equipped with the communication module (optional equipment of the device).

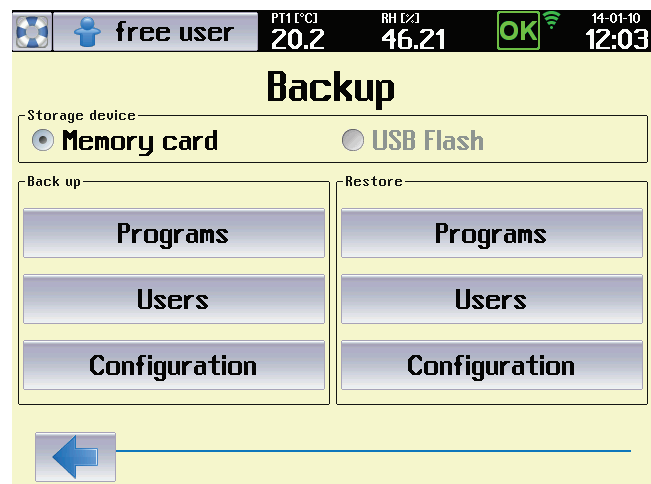

Fig. 40

8.3.10 SERVICE SETTING



8.3.10.1 COMMUNICATION – SETTINGS



→ Communication

Notes:

- Setting the communication interface of the device supposes basic knowledge in the field of computer networks. In case of any unclear matters please contact your information system administrator.

- The settings described in this chapter suppose that the device is equipped with communication module, see 6.15.

8.3.10.1.1 ETHERNET SETTING

The communication interface of the device allows its inclusion to LAN. An example of setting is shown in Fig. 41.

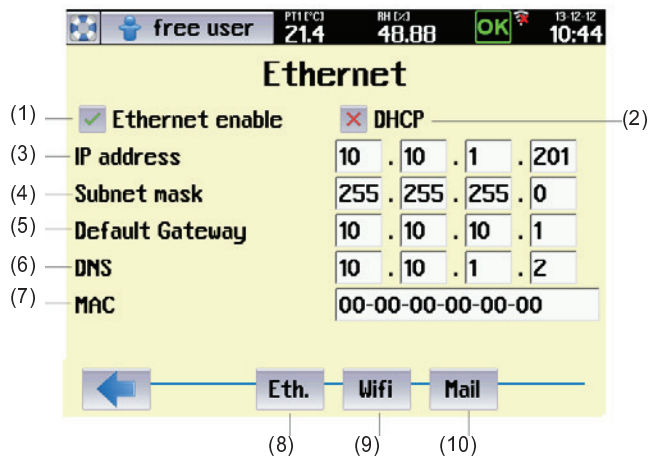

Fig. 41

- (1) Ethernet activation.
- (2) DHCP
 - The user has two possibilities to get the IP address of the device within LAN:
 - o IP address is assigned by the network administrator (see below).
 - o the DHCP option is ticked – then, the IP address is assigned to the device automatically through the DHCP server.
- (3) IP address of the device.
 - Assigned by the LAN administrator.
- (4) Sub-net mask.
 - The sub-net mask is provided by the LAN administrator.
- (5) Initial gate.
 - IP address of the router.
 - Get information from the LAN administrator.
- (6) DNS
 - Address of Local DNS (Domain Name System).
 - Get information from the LAN administrator.
- (7) MAC
 - A unique address of each network device.
 - It is factory adjusted but it can be changed if necessary.
 - If there is set the MAC address 00-00-00-00-00-00, the device uses the MAC address pre-set from the factory. The address is stated in system information, see 8.6.
 - If the user wants to use some other address but the initial one, he may re-type it in this field.

- After editing, you must switch the device on and off using the push button ON/OFF!

- (8) Ethernet setting.
- (9) Wifi setting.
- (10) E-mail setting.
- (11) Web site setting.

8.3.10.1.2 WIFI SETTING

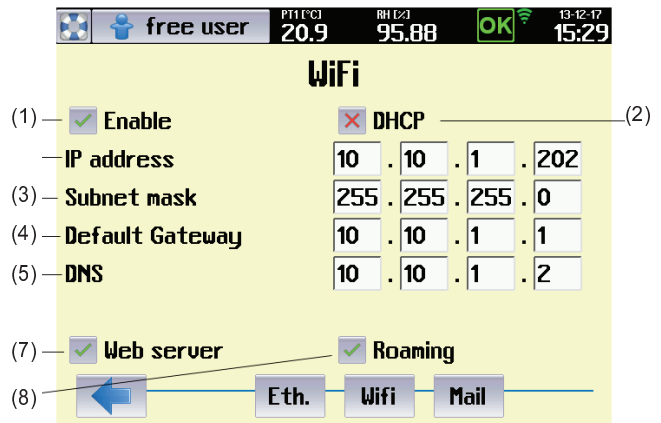

Fig. 42

- (1) Wifi activation
- (2) Automatic assignment of the IP address by the DHCP server.
 - See 8.3.10.1.1.
- (3) IP address of the device.
 - IP address of the device within WLAN.
 - Assigned by the WLAN administrator
- (4) Sub-net mask.
 - Get information from the WLAN administrator.
- (5) Initial gate.
- (6) DNS.
 - Address of Local DNS (Domain Name System).
 - Get information from the WLAN administrator.
- (7) Web server activation.
 - On the communication module it is possible to activate web server, allowing the user to monitor the status of the device, see 8.3.7.3.
- (8) Roaming.
 - The device automatically connects to the access point with the strongest signal.

8.3.10.1.3 E-MAIL SETTING

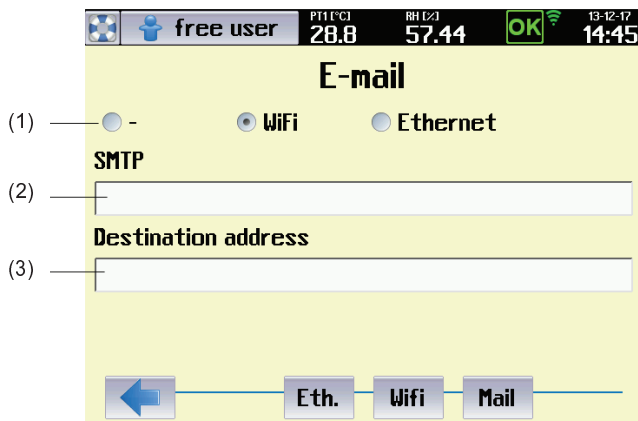

Fig. 43

- (1) Sending
 - Switched off / via Wifi / via Ethernet.
- (2) SMTP.
 - The address of the SMTP server – the address of the server where the user’s e-mail account is created. In case of a request for e-mail communication CLIMACELL EVO connects with the server and the user logs in to his account (see 8.3.7.2), then it is possible to send e-mails to any address.
 - For address of the e-mail server contact your information system administrator respectively you can use any of public providers of e-mail services, e.g. www.gmail.com etc.
- (3) E-mail address.
 - Target address, to which the e-mails are to be sent.
 - There may be any address for which the e-mail server defined by address (2) sends the messages from CLIMACELL EVO.

8.3.10.2 TOUCH PANEL CORRECTION



→ Touch Surface Offset

In this menu it is possible to calibrate the touch panel in such a way so as the push buttons displayed on the display exactly match the active area on the touch panel. With any touch of the relevant push button, the active touch area on the touch panel moves in one pixel in specified direction. Maximal adjustable variation is 100 pixels in any direction. The initial value is $x = 0, y = 0$.

Note:

Display resolution is 640 x 480 pixels.

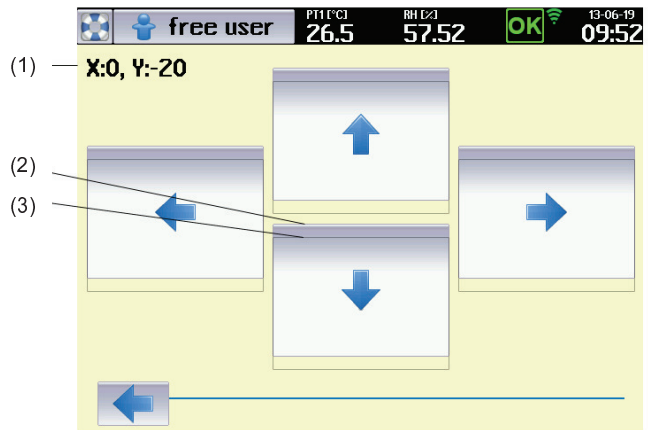

Fig. 44

- (1) Current value of calibration in pixels for axis x and y
- (2) Push buttons for movement of active field of touch panel in given direction.
- (3) New touch surface after movement downwards ($\Delta x = 0, \Delta y = -20$).
 - The field where push buttons react to touch was moved in 20 pixels downwards.

8.3.10.3 UNITS



→ Units

Selection of units for temperature and pressure.

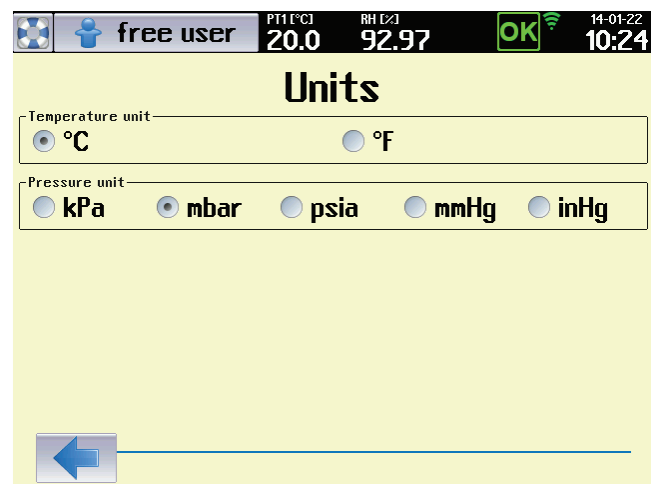

Fig. 45

8.3.10.4 RACK



→ Rack

This service menu serves for entering the value of VIS and UV light intensity under individual light racks in case that the device is not equipped with sensors for light intensity measuring (optional equipment, see 6.11).

The procedure is as follows:

1. The relevant rack is lit to maximal intensity (100 %).
2. The user uses an external measuring gauge for measuring the intensity of visible light IVIS [k.lx], respectively intensity of UV radiation IUV [mW/cm²] below the relevant rack, on the exposed material position.
3. The measured value is entered to the menu according to Fig. 46 and it is saved in the device memory.
4. The saved value of light intensity will be used for calculation of exposition time in programs with light exposition (8.4.4.1).

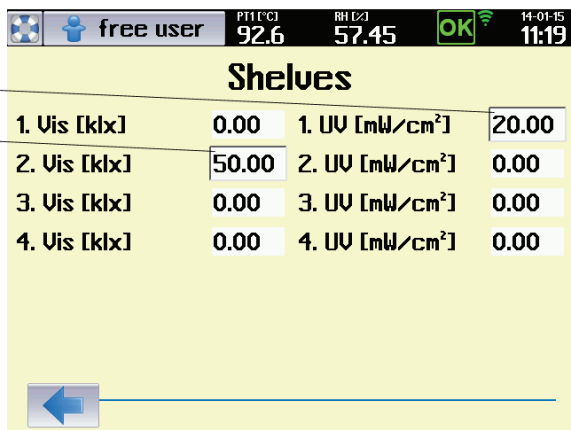

Fig. 46

- (1) Intensity of UV radiation measured below the first UV rack.
- (2) Intensity of visible light measured below the second rack.

8.3.10.5 AUDIT TRAIL



→ Audit trail

The audit trail contains a chronological record of all action performed using the device. The minimum length of each recorded section is ten years, although this may be longer depending on the frequency of the work. Once the memory capacity allocated for the audit trail reaches 90 %, a warning



is issued. A service call-out is required to restore full capacity.



Fig. 47

- (1) Audit trail records.
- (2) Button for export.

The push button  displays a menu for the audit trail export.

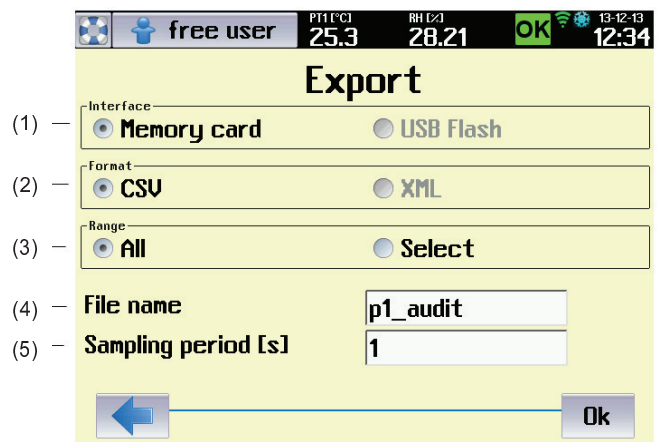

Fig. 48

- (1) Memory medium selection.
 - USB flash disk is allowed only with devices with communication module, see 6.15.
- (2) Record format.
 - Format CSV is suitable for export to the application Microsoft Excel.
 - XML is a universal format supported by many applications.
- (3) Export range.
 - Everything – there is performed the export of complete audit trail.
 - Selection - export starts from the first record on current page. Number of exported records is set by the item (5).

- (4) File name.
 - 8 characters as a maximum.
- (5) Number of exported records.

8.3.10.6 OVERVIEW OF INPUTS AND OUTPUTS

This menu provides information on statuses of all the sensors and action elements within the whole device. It serves mainly for service purposes and it may be used in remote diagnostics of the device. There are displayed the data from all the sensors and current statuses of all the action elements in the device.

8.3.10.6.1 ANALOGUE ITEMS

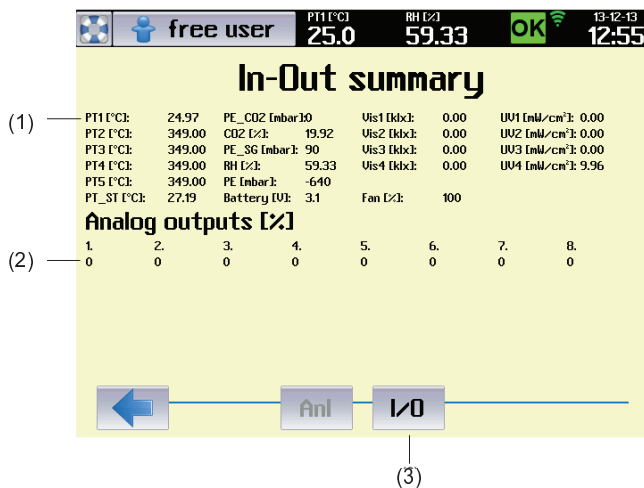

Fig. 49

- (1) Analogue Inputs
 - A set of analogue items measured within the whole device (temperature, pressure, humidity, concentration CO₂, backup battery voltage, data from light sensors).
- (2) Analogue Outputs.
 - Analogue outputs mean the level of analogue control signals, i.e. mainly signals for lighting intensity control.
- (3) Digital inputs and outputs displaying.

8.3.10.6.2 DIGITAL INPUTS AND OUTPUTS

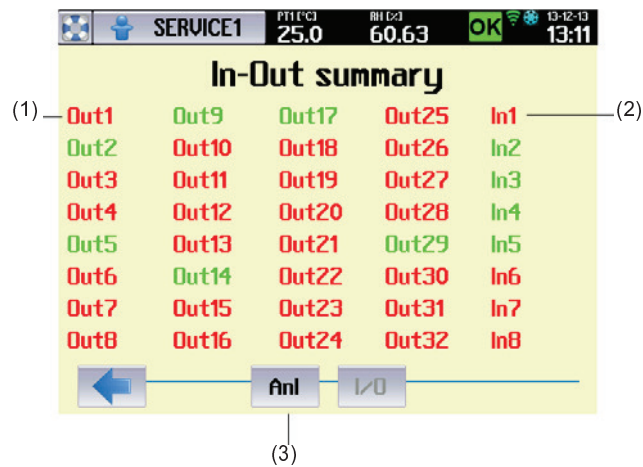

Fig. 50

- (1) Digital Outputs.
 - Output signals for control of individual action elements of the device.
- (2) Digital Inputs
 - In1 up to In8 are digital inputs. The information on statuses of terminal switches and comparators within the scope of the device.
- (3) Transfer to analogue items displaying.

8.3.11 TESTS



The tests serve for checking the correct function of the device.

8.3.11.1 COOLING TEST

We recommend for the cooling test to be performed in case of any suspicion of impaired efficiency of the cooling system. The proper test is performed on an empty device and it consists of three phases:

Test phase	Description
1	Start up to temperature 22 °C.
2	Lead time at temperature of 22 °C for the period of 10 minutes
3	Cooling from 22 °C to 10 °C. The cooling is switched on to maximal output

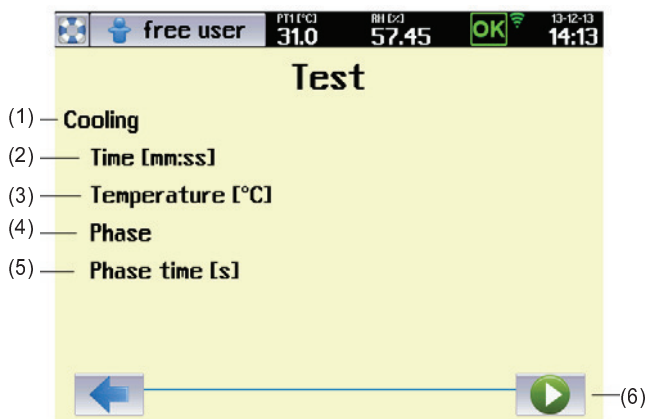

Fig. 51

- (1) Test name
- (2) Total test time.
- (3) Current temperature.
- (4) Current test phase.
- (5) Current test phase time.
 - In the end of the test, this position will continue to display time of phase „3“ (cooling 22 °C → 10 °C). Compare the time with values in the table, see chapter 11.1 „Cooling time“. Tolerance +/- 20 %.
- (6) Start.

8.4 PROGRAMS



The device's memory can store up to 100 programs. Each program may be broken down into 100 fully configurable sub segments

Shows Fig. 55 an example of program P1, consisting of six segments S1 up to S6. Each segment is clearly defined in terms of length and the temperature to be attained in that particular segment. For example, the first segment S1 has the time t1 and the end temperature T1 (i.e. must run to temperature T1 at time t1). The end temperature of segment S2 is the same as that for S1, and is therefore horizontal. The required end temperature for segment S5 is lower than for segment S4 – it is decreasing.

8.4.1 LIST OF PROGRAMS

Start setting the program by pressing  (Fig. 12). This displays the home screen with the list of programs. The user may select from program P1 to P100 (Fig. 52).

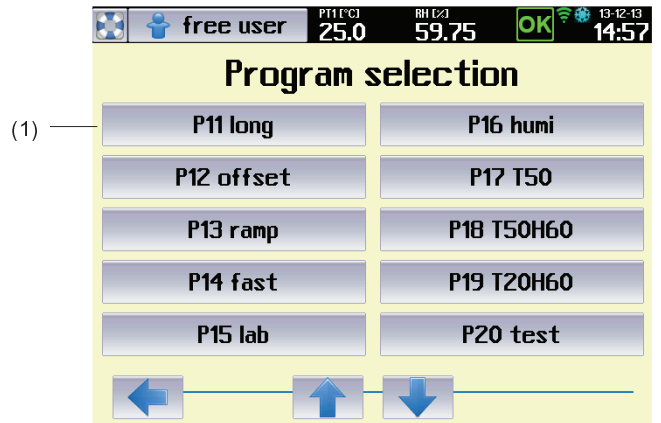

Fig. 52

- (1) Push buttons for relevant program selection.

8.4.2 DEFINITION OF PROGRAM

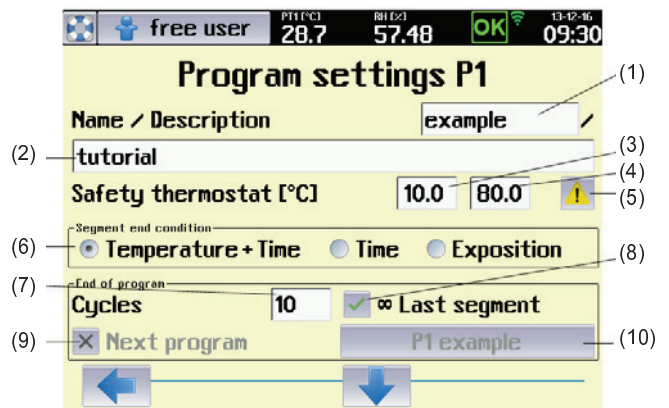

Fig. 53

- (1) Program name.
- (2) Description of program
- (3) Safety thermostat settings – lower limit.
 - See 8.4.2.1
- (4) Safety thermostat settings – upper limit.
- (5) Warning / error selection
 - Selects how the device acts if the temperature rises above (falls below) the set limit. See 8.4.2.1.
- (6) Condition for ending the segment:
 - **Temperature + time** – the segment ends only if the set time has elapsed and the required temperature has also been attained. If at least one of these conditions is not met (i.e. the required temperature has not been attained or the set time has not yet elapsed), the segment continues.
 - **Time** – the segment ends after the set time has elapsed, regardless of whether or not the required temperature has been attained.

- **Exposition** – the segment is terminated in case that there was reached the required exposition of visible light (klx.h) or UV radiation (mW.h/cm²). The exposition selection is possible only at devices with exposition lighting and sensors for measuring the light intensity (see 6.10 and 6.11). For setting of programs with light exposition see 8.4.4.1.

- (7) Number of cycles.
 - May be set within the range 1 to 9999.
- (8) Infinite last segment.
- (9) Selection of programs chaining.
 - Another program may follow after the program termination.
- (10) The following program selection.

8.4.2.1 SAFETY THERMOSTAT

The safety thermostat is used to protect the exposed material, the incubator itself and its surroundings if the temperature in the chamber of the device exceeds (falls below) the maximum (minimum) limit or in the case of regulation complications. Depending on setting of the option (3) and (4), Fig. 53 during activation of protective thermostat

there is announced warning () or fault (). For more details, see 8.3.3.



- If, during regulation, the temperature moves beyond the monitored zone, the heating (cooling) is disconnected. If the temperature spontaneously moves back within the permissible zone, regulation recommences. The device acts as if a warning has occurred.



- If, during regulation, the temperature moves beyond the monitored zone, the heating (cooling) is permanently disconnected. Regulation cannot continue without the operator's intervention. The device acts as if an error has occurred.

8.4.3 PROGRAM CONFIGURATION

This menu is used to select variables and accessories that are to be active in the program in question.

Notes:

- The variables that can be selected in this menu depend on the specific configuration of the device
- The options CO₂, Internal socket, UV lighting, VIS lighting, Defrosting are only available on devices with the appropriate optional equipment, see 6.9, 6.10, 6.14.

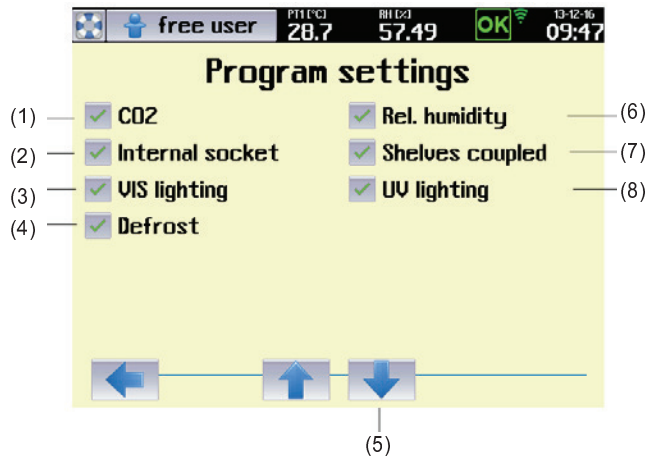

Fig. 54

- (1) CO₂
 - Optional device accessories.
 - For devices with CO₂ regulation.
- (2) Internal socket.
 - Optional device accessories, see 6.9.
 - In the course of the program, this socket may be switched on (switched off), see 8.4.4.
- (3) Light exposition – visible light
 - Optional device accessories, see 6.10.
 - For devices with lighting on light racks (visible light).
- (4) Automatic defrosting of cooling system
 - Optional device accessories.
 - This option should be used particularly for programs with long-term and intense cooling, when the condensate on the cooling unit gradually freezes, thus reducing efficiency. If this option is activated, the heating medium will be injected into the cooling system at regular intervals (depending on the program settings and the specific type of device), which will remove any ice. This is done to minimise the impact on temperature and humidity regulation in the working part of the incubator; for the duration of this operation the fan speed is reduced to 10 %.
 - We recommend using this within the temperature range from 0 °C to the ambient temperature.
- (5) Transfer to segments editing.
- (6) Relative humidity.
- (7) Coupled racks.
 - Option only for devices with UV or VIS racks (6.10.2).
 - In case of active selection, all the UV racks (respectively all the VIS racks) are controlled simultaneously. If the option is not ticked, every rack is controlled independently.
- (8) UV exposition.
 - Optional equipment of the device, see 6.10.2.

8.4.4 SEGMENT SETTINGS

The next step is to set the program sub-segments. Fig. 55 shows the example of temperature regulation program P1, which consists of six segments, S1 to S6. Each segment has a defined time and temperature that is to be attained within that specific time.

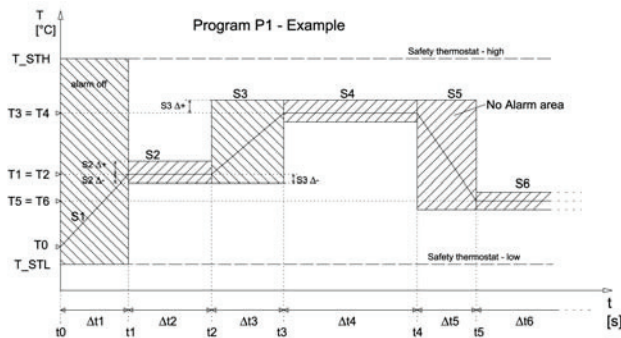



Fig. 55

The parameters of each segment can be set in the segment

editing menu, which is reached by pressing  (Fig. 56).

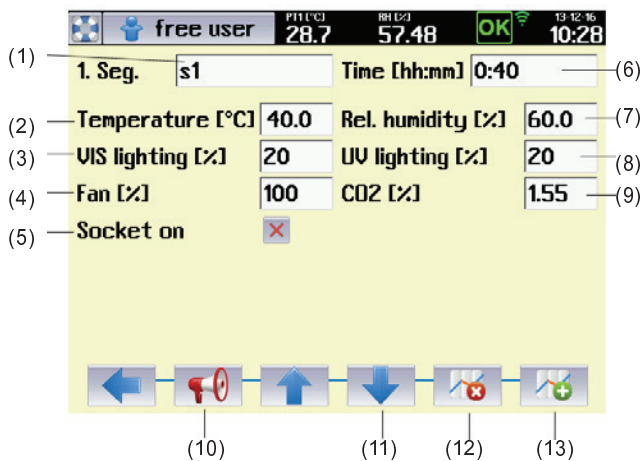



Fig. 56

- (1) Segment name.
- (2) Required temperature at end of segment.
 - Temperature to be attained at the end of the segment.
- (3) Required VIS lighting intensity at end of segment.
 - Only on devices with light racks, see 6.10.
- (4) Required fan speed at end of segment.
 -  Decrease of revolutions may have negative effect on precision of temperature regulation and relative humidity regulation as well as to

space thermo homogeneity in the chamber of the incubator.

- For optimal regulation we recommend setting to 100 %.
- (5) Switching on the internal socket.
 - See 6.9.
 - The socket may be switched on (off) within the segment.
- (6) Length of segment
- (7) Required humidity at end of segment.
- (8) UV lighting intensity at the end of the segment.
 - Only on devices with light racks, see 6.10.
- (9) The required CO₂ concentration at the end of the segment.
 - Only on devices with CO₂ regulation, see 6.14.
- (10) Alarm settings.
 - See 8.4.4.2.
- (11) Switch to next segment.
- (12) Delete segment.
- (13) Add segment.

Notes:

- The target value of the horizontal segment is the same as the target value of the previous segment. For example, the required temperature for segment S2 (Fig. 55) is the same as for the previous segment (S1), and it is therefore horizontal.
- If a blank character is inserted into the variable target value column (i.e. the column is cleared by pressing ) , that variable will not be regulated in that segment. If, for example, no value is entered for any of the variables in the 1st segment, the device will not be regulated at all for the defined period of time. This can be used to move the start of the program by any time period.

 **Allowed combinations of temperature, relative humidity and lighting are specified in chapter 8.4.5.**

8.4.4.1 SETTING OF PROGRAMS WITH LIGHT EXPOSITION

Programs with light exposition have only one segment, in which the material under an appropriate rack faces the influence of UV (VIS) light. The intensity of lighting of all the racks is set during material exposition to maximal value (100 %). The user sets the required exposition in the menu for segment setting (Fig. 57). The exposition starts automatically after reaching the required parameters in the device chamber (temperature, humidity and possibly others). The light intensity below the relevant rack is measured by a sensor. After exposition time expiration the lighting is switched off.

Note:

- A condition for finishing a program in programs with light exposition is the selected exposition (see Fig. 53).
- In case of the device not to be equipped with sensors for light intensity measuring, there must be set the value of VIS or UV light intensity according to 8.3.10.4.

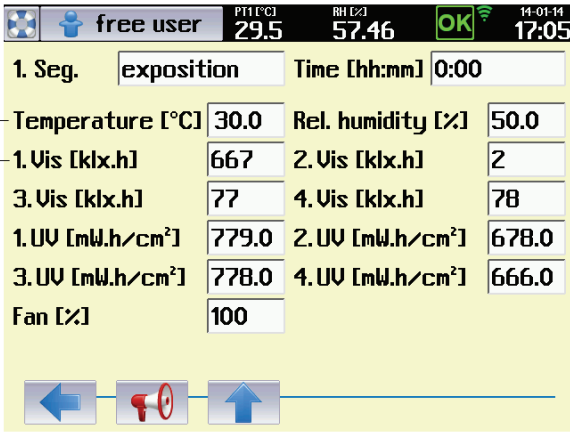

Fig. 57

- (1) Required exposition conditions.
- (2) Light exposition for individual racks.

8.4.4.2 ALARMY



Alarms warn the user that one of the regulated variables has moved outside the pre-set limits. The temperature, relative humidity and CO₂ concentration can be monitored (CO₂ is an optional device accessory, see 6.14). How the device acts when the alarm is triggered depends on the settings for the button (3), fig 58, and is the same as when a warning or error occurs (see 8.3.3).

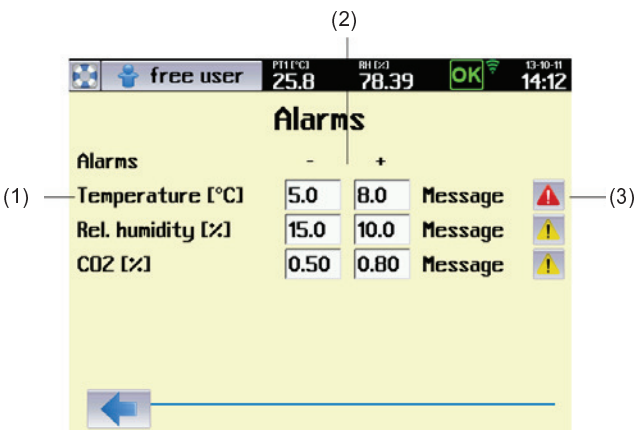

Fig. 58

- (1) Monitored variable
 - Alarms may be set for temperature, humidity and CO₂ concentration
- (2) Setting monitored limits
 - See fig. 55.
 - With horizontal segments the system monitors limits defined by positive and negative deviations from the required variables – segments s2, s4, s6.
 - Definition of monitored zone for ramps – segments s3, s5.
 - If 0 % is set for a positive and negative deviation, the alarm is switched off - segment s1. The temperature in the chamber is then monitored by the safety thermostat only (8.4.2.1).
- (3) Device action when an alarm occurs.
 - device acts as if a critical error has occurred.
 - device acts as if a warning has occurred.

Note:

If a certain variable needs to be quickly ramped up to its target value in a segment (typically temperature or humidity), when switching to the next (horizontal) segment, there may be a slight overshoot above the required value. This cannot be completely eliminated during regulation. Therefore, in such cases we recommend setting the alarm limits so that the tolerated band is not too narrow, or first testing out the alarm settings.

8.4.5 TEMPERATURE AND RELATIVE HUMIDITY SETTING AND THEIR LIMITATIONS

The mutual relation of operation temperature (T °C) and operation relative humidity (RH %) when setting the operation parameters of the case depending on additional equipment is illustrated in the enclosed scheme.

Temperature and relative Humidity Setting and Their Limitations

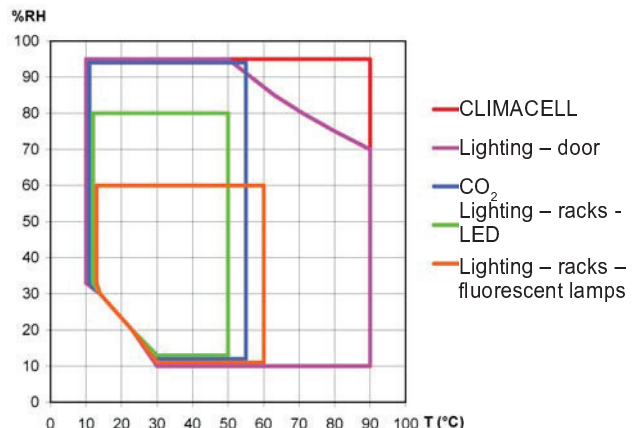

Fig. 59

8.4.6 PROGRAM START MENU

After all the segments setting and program saving we reach the menu where it is possible to start the program respectively to further adjust it.

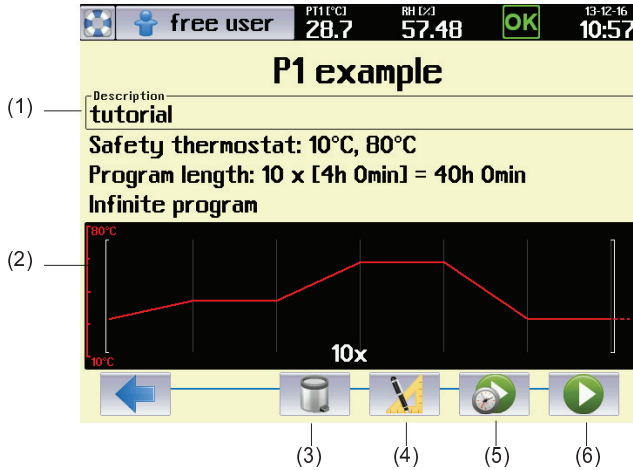



Fig. 60

- (1) Basic data of the program.
- (2) Schematic display of the program course.
- (3) Program deletion.
- (4) Program adjustment.
- (5) Delayed program start.
- (6) Program start.

8.4.7 PROGRAMU START



The program is started by push button , Fig. 60. The display starts to show graphic displaying of the program items depending on time (Fig. 61). The upper bar shows current values of temperature and relative humidity in the chamber.

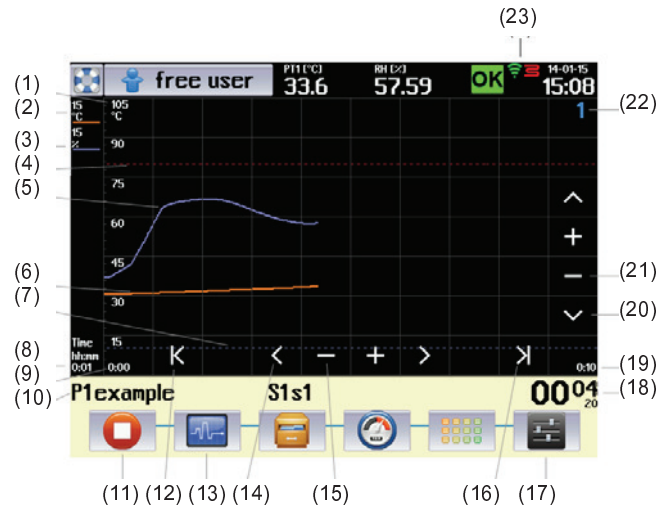











Fig. 61

- (1) Vertical axis description – the axis for currently displayed item (temperature).
- (2) Description of vertical axis for the first item (temperature).
- (3) Description of vertical axis for other items (humidity, CO₂, etc.)
 - By touching the axis description there will be switched over the vertical axis for the relevant item.
- (4) Protective thermostat setting – upper limit.
- (5) Graphic record of second item regulation (humidity).
- (6) Graphic record of first item regulation (temperature).
- (7) Protective thermostat setting – lower limit.
- (8) Time axis description – format and scale.
 - The scale is in the format of time / one graph section.
 - In our example 1 min. / section.
- (9) Start of displayed time section.
 - In our case there is displayed the course of regulation in the range from 0:00 hour to 0:10 hour as from the program start.
- (10) Information on active program and segment. Field for operation reports
- (11) Stop the program.
- (12) Push button for movement to the beginning of record.
- (13) Program editing.
- (14) Movement backward / forward
 - Based on touch, the displayed field of the graph moves in the direction of negative (positive) time axis.
- (15) Change of time axis scale.
 - „-“ displays a longer time interval.
 - „+“ displays a shorter time interval.
- (16) Push button for movement to the end of record.
- (17) Graph setting (see 8.4.7.1).
- (18) Displaying the time data of the program (see 8.4.7.1).
 - The format of displaying depends on setting them graph parameters - see 8.4.7.1.
 - c – it has the meaning of the number of finished cycles.

- d – it has the meaning of the number of passed days
- (19) End of displayed time interval.
- (20) Movement upwards / downwards.
 - Based on touch, the displayed field of the graph moves in the direction of negative (positive) axis y.
- (21) Push buttons for setting the vertical axis scale.
- (22) Identification number of the device.
 - See 8.3.7.
- (23) Information on device operation.

-  - heating
-  - cooling
-  - visible light
-  - UV
-  - visible light + UV
-  - USB device connected
-  - Wifi – full signal
-  - Wifi – weak signal
-  - Wifi – very weak signal
-  - Wifi – no signal

8.4.7.1 RUNNING PROGRAM GRAPH



The parameters of the running program graph can be set

after clicking on the icon  Fig. 61.

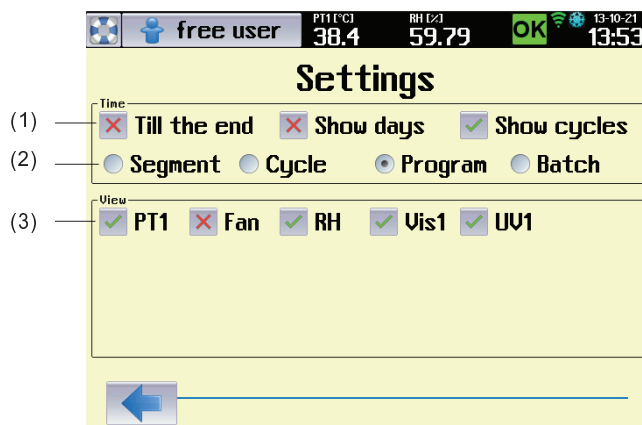

Fig. 62

- (1) Options for time displaying
 - „BY END“ – it displays the time remaining by the end of selected part of the program.
 - „display days“ – it shows passed days.
 - „display cycles“ – it shows passed cycles.
 - Time is displayed in format HHHHH:MM:SS. Maximal time that can be displayed is 65535 hours.
 - In case of selection „Display days“ the time is displayed in the format DDDDD:HH:MM:SS. Maximal time that can be displayed is 65535 days.
- (2) Part of the program, to which the time information relates.
 - A batch means chaining of several programs one after the other.
- (3) Displayed items selection.
 - The offer in this field depends on concrete configuration of the device.

8.4.7.2 RUNNING THE PROGRAM WITH LIGHT EXPOSITION

In case of programs with light exposition the information about the program is displayed in a different format compared to other programs (exposition programs - see 8.4.4.1.).



Fig. 63

- (1) Current light dose in given time.
- (2) Push button for manual switch on (off) of light racks.

8.4.7.3 POSTPONED START OF PROGRAM



Postponed start of the program allows automatic start of the program in set time. It is possible to start the program in any point of the cycle (program, segment).

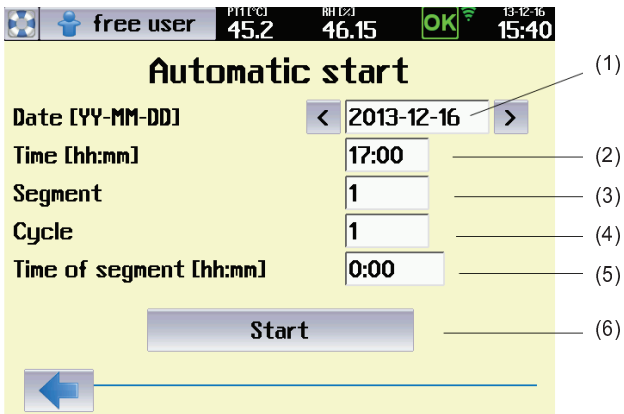

Fig. 64

- (1) Automatic start date
- (2) Automatic start time
- (3) Segment, from which the program is to start.
- (4) Cycle, from which the program is to start.
- (5) Time of start within the selected segment.
- (6) Start confirmation.

Notes:

- After confirmation of postponed start the display shows a message with date and time of program start. The only active push button is that for operation cancelling.
- After confirmation of postponed start of the program, the user is logged out in the mode of advanced administration of users (8.3.2.2). Then, the device is in mode „no login“.



Fig. 65

- (1) Date and time of postponed start.

8.4.7.4 DOOR OPENING

In case of the door to be open in the course of the program, the field (1), Fig. 67 displays a relevant message and there

is announced a warning . The device continues in program performance, the event is recorded in audit trail.

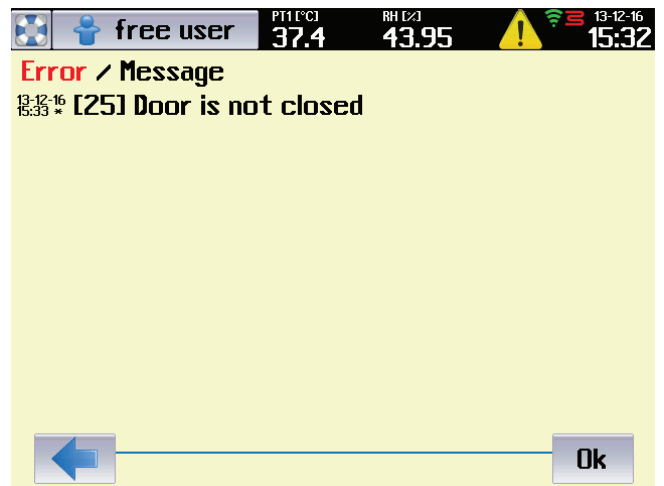

Fig. 66

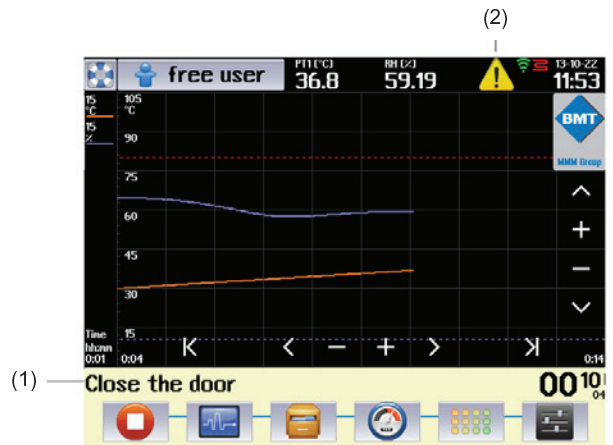

Fig. 67

- (1) Message in the bar.
- (2) Warning.

8.4.7.5 DOOR BLOCKING

The device may be equipped with an electromagnetic mechanism, preventing undesirable door opening (optional equipment of the device, see 6.4).

8.4.7.5.1 DOOR BLOCKING IN THE MODE WITHOUT USERS ADMINISTRATION

In the mode when there is not activated advanced administration of users, the user may manually activate (deactivate) the door blocking. Blocking (de-blocking) is

activated by touching the icon  (). Device login is not required for the door control.

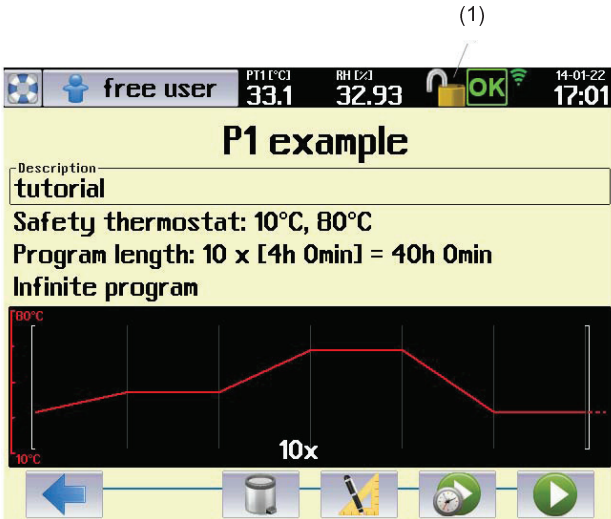





Fig. 68

- (1) Door blocking icon
 - Blocking is activated (deactivated) by touch.

8.4.7.5.2 DOOR BLOCKING IN THE MODE OF ADVANCED USERS ADMINISTRATION

If there is activated the advanced administration of users, the blocking control is conditioned by the user's login. The right to block (unblock) the door have all the defined users regardless their assignment into groups. After login, the user may activate (de-activate) blocking by touching the icon  (). After logout of a user, the door is blocked. In case of automatic user's logout setting (see 8.3.2.2.1, Fig. 16) the door is automatically blocked after specified time expiration.

8.4.7.6 CURRENTLY RUNNING PROGRAM EDITING

The user may change parameters of currently running program. Using push buttons  (Fig. 67) and  (Fig. 69) you can reach the menu for program editing, see 8.4.2.

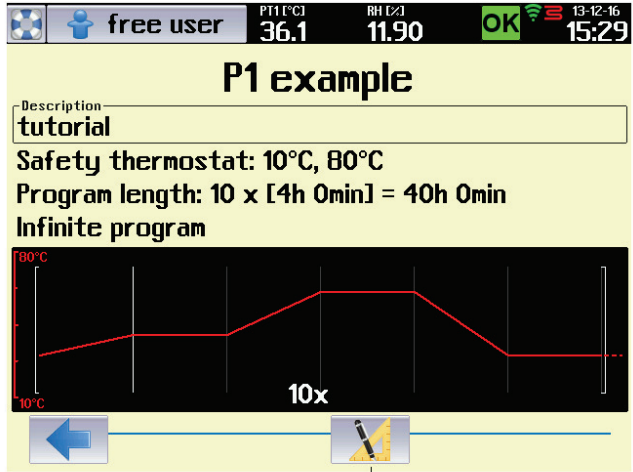

Fig. 69

- (1) Entry to program editing.

After finishing the editing, the user is asked whether he wants to interrupt the currently running program and save changes.

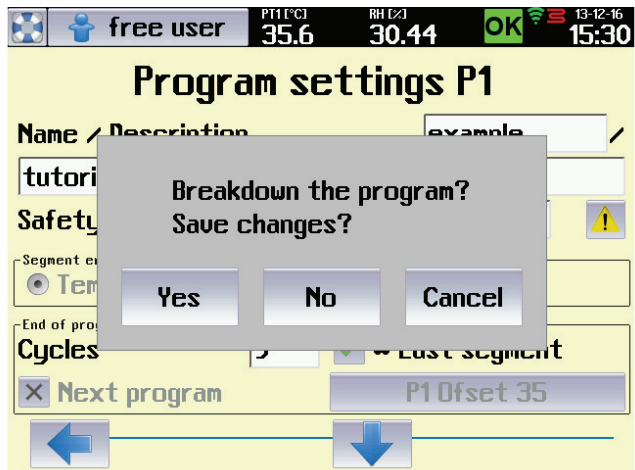



Fig. 70

After confirmation by push button  the new setting of the program is saved in the device memory and there is displayed the menu for postponed start of the program (see 8.4.7.3). In this menu, the user may select the cycle of the segment, respectively time of segment, when the program is to start. The push button  starts the program with new settings regardless the time specified in the editing field „Time“.

8.4.7.7 POWER SUPPLY OUTAGE

In case of power supply network outage in the course of the program run, all the running program settings are preserved and even the real time clock goes on in the course of the outage.

The device behaviour during an outage depends on setting of the condition for the segment finishing (see 8.4.2):

- Temperature + time or batch
 - o after power supply restoration the program will continue exactly from the point of the segment where it was interrupted.
- Time
 - o after power supply restoration there will continue exactly the time that passed from the program start. The part of the program that should have been performed in the course of the outage is omitted.

8.5 HISTORY OF PROTOCOLS



The history of protocols keeps information on programs run in recent 30 days. In the protocol there are saved samples of all the program items with a period of 1 s. The history of

protocols is displayed using the icon , Fig. 12.

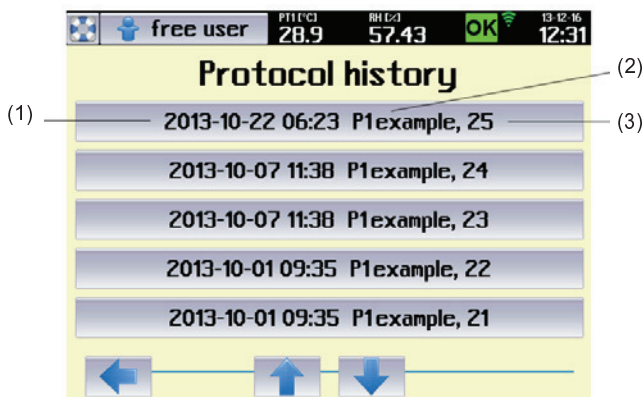

Fig. 71

- (1) Date and time of program running.
- (2) Program name.
- (3) Protocol order in the history.

A relevant graph is displayed after selection of an item from the list:



Fig. 72

- (1) Lower limit of selection
 - When touching any point of the graph, a white cursor is displayed in the touch point.
 - The push button changes the cursor colour to green. The green cursor marks the lower limit of the selection.
- (2) Upper limit of selection (export).
 - The push button changes the cursor colour to red. The red cursor marks the upper limit of the selection.
- (3) Protocol printing.
- (4) Protocol export.
- (5) Cursor for lower limit of the range.
- (6) Cursor for current value
- (7) Cursor for upper limit of the range.

Push button  (Fig. 72) displays the menu for protocol export.



Fig. 73

- (1) Memory medium selection
 - USB flash disk is possible only with devices with communication module, see 6.15.
- (2) Record format.
 - Format CSV is suitable for export to Microsoft Excel.
- (3) Export range.
 - It is possible to export complete record or a part of it.
- (4) File name.
 - 8 characters as a maximum.
- (5) Sampling period.
 - Sampling period = 1 s, means that there will be exported all the saved samples from the selected interval (maxima data volume). Sampling period = 2 s, means that there will be exported every second sample (half data volume), etc.

8.6 SYSTEM INFORMATION



After clicking the icon (Fig. 12) there will be displayed all and any system information of the device, values of all the measured items and status of action elements.

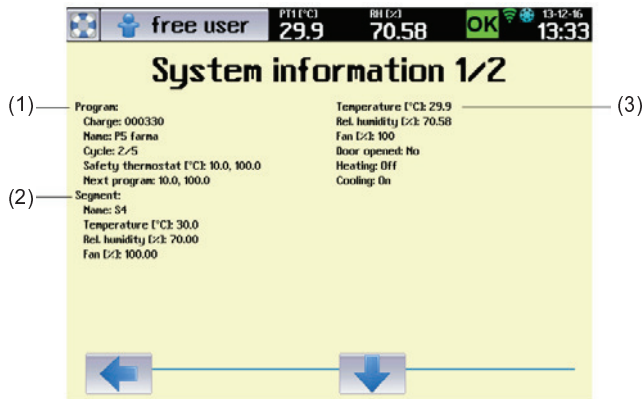

Fig. 74

- (1) Information on running program.
- (2) Information on running segment.
- (3) Currently measured values and current status of action elements.

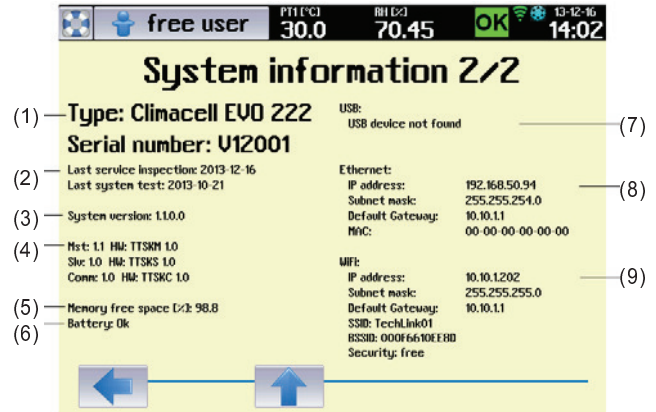

Fig. 75

- (1) Device type and serial number.
- (2) Records of tests and system updates.
- (3) Main version of the system.
- (4) System sub-version.
- (5) Free capacity of memory for history of programs and audit rail.
- (6) Backup battery status.
- (7) Connected USB device.
- (8) Device setting within LAN.
- (9) Device setting within WLAN.

9 LIST OF ERROR MESSAGES

Number	Location	Name	Relevance	Cause	Way of elimination
1	Mst	System version error	Hard	There is a set of firmware in the device which is mutually incompatible	Contact authorised service
2	Mst	Faulty program definition.	Hard	Started program is damaged or the program version is incompatible with the firmware version.	Repeat the program editing and save the program again. Contact authorised service in case that the problem persists
3	Mst	Faulty device configuration.	Hard	The configuration saved in the device is damaged or its version does not correspond to current version of firmware.	Contact authorised service
4	Mst	Faulty access rights.	Hard	Access rights of users saved in the device are damaged or their version does not correspond to current version of firmware.	The administrator checks the access rights setting. Contact authorised service in case that the problem persists
5	Mst	Fault of connection between Mst and Com.	Soft	Error in communication with communication module.	Contact authorised service
6	Mst	Fault of connection between Mst and Slv.	Hard	Error in communication with module Slv.	Contact authorised service
7	Mst	Error in protocol recording.	Hard	Data of the protocol not entered in internal memory of the device.	Contact authorised service
8	Mst	Large-capacity memory error.	Hard	An error in work with internal memory of the device.	Contact authorised service
9	Mst	Program run error.	Hard	An unexpected step occurred in the program run.	Repeat program setting, save it and start again. Contact authorised service in case that the problem persists
10	Mst	Discharged battery.	Hard	Critical level of battery voltage. Immediate replacement necessary.	Contact authorised service
11	Mst	Discharged battery.	Soft	Low level of battery voltage. Replacement recommended.	Contact authorised service
12	Mst	Power blackout.	Hard	Network feeding failure exceeding 7 days or program run not restored after blackout due to discharged backup battery.	Arrange for any blackout not to exceed 7 days. In case of discharged battery call authorised service.
13	Mst	Date and time.	Hard	Invalid date and time.	If the battery is discharged, call authorised service.
22	Slv	Too high pressure in generator.	Hard	Fault of heating body or pressure sensor.	Contact authorised service
23	Slv	High temperature in generator.	Hard	Fault of heating body or temperature sensor for body overheating.	Contact authorised service
24	Slv	Overpressure valve of generator.	Hard	There was activated the pressure fuse of steam generator or steam leakage detector failed.	Contact authorised service
25	Slv	Door not closed.	Soft	Open door or faulty door switch.	Check whether the door is closed, respectively contact authorised service.
26	Slv	Generator cannot be pressurised.	Soft	Fault of heating body or pressure sensor.	Contact authorised service
27	Slv	Discharge vessel cannot be emptied.	Soft	Decreased permeability of waste water drain (e.g. broken hose), faulty pump or floating switch.	Check permeability of waste water drain respectively contact authorised service.
28	Slv	Generator cannot be filled.	Soft	Decreased permeability of water intake (e.g. broken hose), faulty pump or floating switch.	Check permeability of water intake respectively Contact authorised service.
29	Slv	Unexpected reset of Slv.	Soft	Short failure of feeding voltage, network voltage oscillation	Contact authorised service in case of repeated occurrence.
50	Mst	Protective thermostat interrupted.	Hard		Contact authorised service
51	Mst	Protective thermostat short-circuited.	Hard		Contact authorised service
52	Slv	Regulation Pt interrupted.	Hard	Faulty temperature sensor.	Contact authorised service
53	Slv	Regulation Pt short-circuited.	Hard	Faulty temperature sensor.	Contact authorised service

Instructions for use

54	Slv	Humidity sensor interrupted.	Hard	Faulty sensor or source +24 V.	Contact authorised service
55	Slv	Humidity sensor short-circuited.	Hard	Faulty sensor or source +24 V.	Contact authorised service
56	Slv	Flexible Pt 1 interrupted.	Soft	Faulty temperature sensor.	Contact authorised service
57	Slv	Flexible Pt 1 short-circuited	Soft	Faulty temperature sensor.	Contact authorised service
58	Slv	Flexible Pt 2 interrupted..	Soft	Faulty temperature sensor.	Contact authorised service
59	Slv	Flexible Pt 2 short-circuited	Soft	Faulty temperature sensor.	Contact authorised service
60	Slv	Flexible Pt 3 interrupted.	Soft	Faulty temperature sensor.	Contact authorised service
61	Slv	Flexible Pt 3 short-circuited.	Soft	Faulty temperature sensor.	Contact authorised service
62	Slv	Flexible Pt 4 interrupted.	Soft	Faulty temperature sensor.	Contact authorised service
63	Slv	Flexible Pt 4 short-circuited	Soft	Faulty temperature sensor.	Contact authorised service
64	Slv	CO ₂ sensor short-circuited.	Soft	Faulty sensor or source +24 V.	Contact authorised service
65	Slv	CO ₂ sensor interrupted.	Soft	Faulty sensor or source +24 V.	Contact authorised service
66	Slv	Pressure sensor short-circuited.	Soft	Faulty sensor or source +24 V.	Contact authorised service
67	Slv	Pressure sensor interrupted.	Soft	Faulty sensor or source +24 V.	Contact authorised service
68	Slv	Light sensor 1 short-circuited.	Soft	Faulty sensor or source +24 V.	Contact authorised service
69	Slv	Light sensor 1 interrupted	Soft	Faulty sensor or source +24 V.	Contact authorised service
70	Slv	Light sensor 2 short-circuited.	Soft	Faulty sensor or source +24 V.	Contact authorised service
71	Slv	Light sensor 2 interrupted	Soft	Faulty sensor or source +24 V.	Contact authorised service
72	Slv	Light sensor 3 short-circuited.	Soft	Faulty sensor or source +24 V.	Contact authorised service
73	Slv	Light sensor 3 interrupted	Soft	Faulty sensor or source +24 V.	Contact authorised service
74	Slv	Light sensor 4 short-circuited.	Soft	Faulty sensor or source +24 V.	Contact authorised service
75	Slv	Light sensor 4 interrupted	Soft	Faulty sensor or source +24 V.	Contact authorised service
76	Slv	UV sensor 1 short-circuited	Soft	Faulty sensor or source +24 V.	Contact authorised service
77	Slv	UV sensor 1 interrupted	Soft	Faulty sensor or source +24 V.	Contact authorised service
78	Slv	UV sensor 2 short-circuited	Soft	Faulty sensor or source +24 V.	Contact authorised service
79	Slv	UV sensor 2 interrupted	Soft	Faulty sensor or source +24 V.	Contact authorised service
80	Slv	UV sensor 3 short-circuited	Soft	Faulty sensor or source +24 V.,	Contact authorised service
81	Slv	UV sensor 3 interrupted	Soft	Faulty sensor or source +24 V.	Contact authorised service
82	Slv	UV sensor 4 short-circuited	Soft	Faulty sensor or source +24 V.	Contact authorised service
83	Slv	UV sensor 4 interrupted	Soft	Faulty sensor or source +24 V.	Contact authorised service
100	Mst	Internal error Mst 100	Hard	Fault of reading EEPROM Mst	Switch the device on and off using the network switch. Contact authorised service in case that the problem persists.
101	Mst	Internal error Mst 101	Hard	Fault of writing to EEPROM Mst	Switch the device on and off using the network switch. Contact authorised service in case that the problem persists.
200	Slv	Internal error Slv 200	Hard	Fault of reading EEPROM Slv	Switch the device on and off using the network switch. Contact authorised service in case that the problem persists.
201	Slv	Internal error Slv 201	Hard	Fault of writing to EEPROM Slv	Switch the device on and off using the network switch. Contact authorised service in case that the problem persists.
202	Slv	Internal error Slv 202	Hard	Fault of fuzzy regulator of temperature (this should never occur)	Switch the device on and off using the network switch. Contact authorised service in case that the problem persists.

203	Slv	Internal error Slv 203	Hard	Fault of fuzzy regulator of RH (this should never occur)	Switch the device on and off using the network switch. Contact authorised service in case that the problem persists.
400	Comm	Internal error Com 400	Soft	Fault of reading EEPROM Com	Switch the device on and off using the network switch. Contact authorised service in case that the problem persists.
401	Comm	Internal error Com 401	Soft	Fault of writing to EEPROM Com	Switch the device on and off using the network switch. Contact authorised service in case that the problem persists.
403	Comm	Internal error Com 403	Soft	Unexpected reset Com	Switch the device on and off using the network switch. Contact authorised service in case that the problem persists.

10 DEVICE MAINTENANCE

10.1 MAINTENANCE PLAN



In case of long-term cut off of the device discharge water from the cask, generator and waste vessel. Avoid any device pollution with ditch water. Dry the device and its parts and we also recommend its washing with suitable disinfection means.



Perform any replacement, setting, cleaning, etc. only with cooled down and disconnected device!



In case of the device to be used in any other but recommended way, the device protection may be impaired.

Frequency	Controlled part	Performed by	Note
continuously	Control of hoses and hose connections for leakage, cleanness of mesh on submersible pump	staff	
continuously	Control of water quantity and cleanness in the cask (min. level height 25 cm)	staff	Pollution may occur after long-term set-off
continuously	Control of waste vessel cleanness	staff	Pollution may occur after long-term set-off
continuously	Cleaning of inner sheets, chamber, shell, touch screen	staff	As needed
continuously	Control of door tightness	staff	Replacement, as needed
min. 1/2 year	Visual control of integrity of insulation of flexible temperature sensors	staff	
1 year	Control of door locking mechanism	service	
1 year	Condensate cleaning in cooling circuit	service	Dirt between lamellas impairs the cooling circuit function
1 year	Protective thermostat control	service	
1 year	Relief valve functionality control	service	
1 year	Control of electric installation – mainly integrity of insulation of conductors, intake, connection and protective clamps, strength of conductors connection in clamps	service	Protective connection resistance is < 0,1 Ohm, the intake resistance is not included
1 year	Control of hose connection CO ₂	service	

10.2 DOOR SEALING REPLACEMENT

- (1) Outer door sealing (m. No. 0672719 size 111 - 707)



- (2) Glass door sealing (m. No. 0672718)



- (3) Sealing between doors (m. No. 0672720, only size



707)

- (4) Sealing of outer door, different for size 1212.

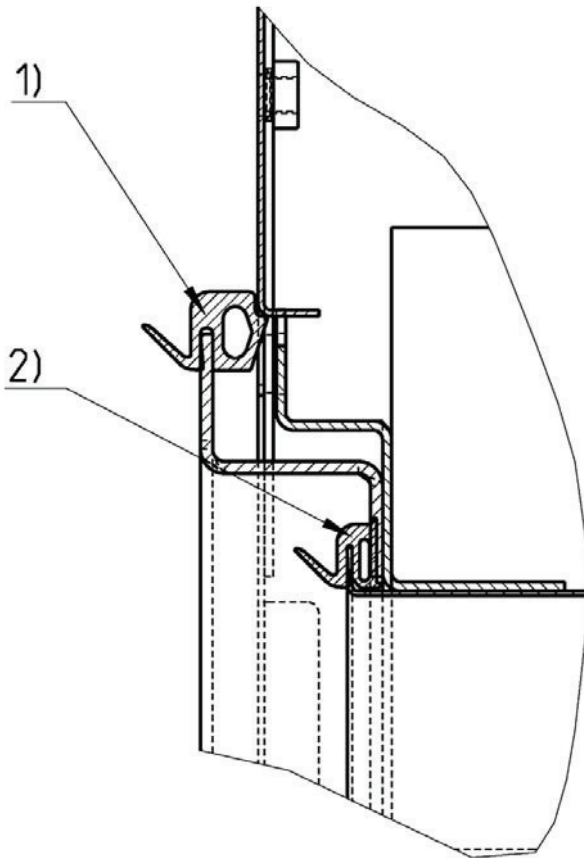

Fig. 76

- The sealing (1) is inserted between the chamber and the shell.
- The sealings (2) and (3) are put on the sheet edge – you can remove them easily (start from the bottom centre).
- Re-apply a new sealing on the edge (start from the bottom centre).

10.3 DOOR ADJUSTMENT

The glass door has a fixed position and it can be only turned around its axis or get out of hinges.

The outer sheet door is adjustable in all the four positions (see Fig. 76):

- (1a) – unscrew three cross screws and extend the super structure towards the rear part of the device.
- (1), (2) – four screws with inner hexagon (imbus 6).
- (3), (4) – screws secured with a nut (cross-head screwdriver, wrench 10).

Adjust the door in such a way so as – after their closing – the rubber sealing of the chamber is pushed on the whole circumference to the sheet of the floating door. Check it in such a way that before full closing of the door insert a sheet of paper between the sealing and the sheet of the floating door – after the door closing, the paper may be taken out based on slight resistance.

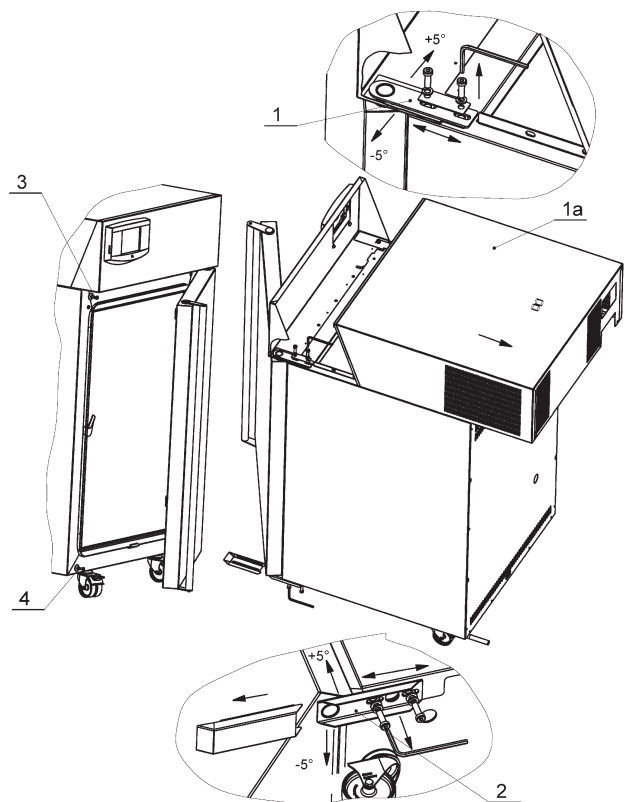

Fig. 77

10.4 ACCUMULATION OF CONDENSED WATER STEAM

When the incubator is operated under specific conditions (high humidity), condensate may accumulate in the space between the glass door and outer door. The condensate is collected below the glass door and it is taken away to the waste vessel placed below the device.

10.5 DEVICE CLEANING AND DECONTAMINATION



Clean only cold and mains disconnected device!

Clean inner walls (removable) with water with detergent, respectively use suitable chemical means. You can use the same means for cleaning the interior of the chamber after removal of inner walls - see Fig. 77.

Clean the external surface of the device shell only with cloth dampened with water and detergent.



Take care for water not to flow behind the control panel.



Clean the touch screen with screen-cleaning means only.



Do not use any abrasive cleaning means – they may cause sheet scratching.



While handling the inner sheets in the chamber take extreme care not to cut the chamber sealing.



When disconnecting the waste vessel connector hold the female connector and pull the male connector.

Dismantling of internal walls – according to arrows

(1) – glass door, (2) – screens, (3) – upper wall, (4) – side walls, (5) – bottom, (6) – rear wall

You can assemble the chamber by reverse procedure. Take care for all the stops to fit each other.

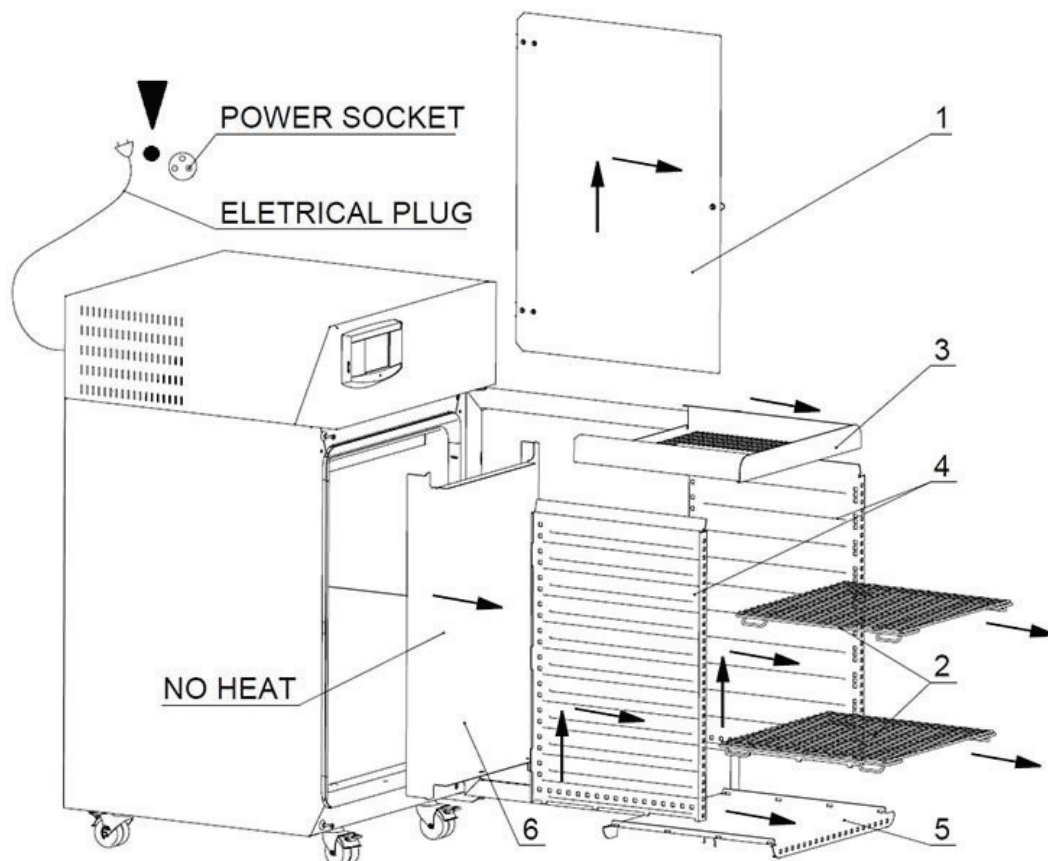

Fig. 78

In case of contaminated material leakage to the chamber of the device, the user is responsible for appropriate performance of decontamination of all and any contaminated surfaces with suitable and approved disinfection means.

Before using any other method of cleaning or decontamination than the methods recommended by us it is purposeful for the user to check at the manufacturer that the method could not do any harm to the device.

Waste vessel dismantling – according to arrows

(1) – Male / female connector (pump and level switch feeding), (2) – Vessel for waste water (with a pump, level switch and hose).

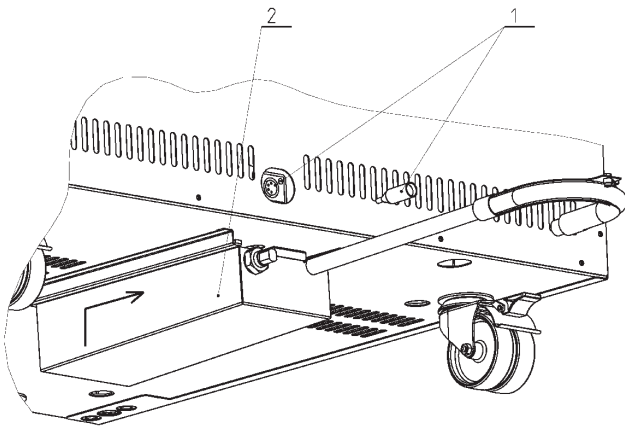

Fig. 79

10.6 STEAM GENERATOR

It is located in the rear part of the device, below the cover. Check hose tightness only, the other parts of the generator will be checked by a service technician. It should be performed at least once per year.

10.7 REVISION OF ELECTRO PARTS

The temperature engineering cases are designed for basic standard environment, the manufacturer recommends the revision period of 1 year, unless set otherwise by local regulations.

In case of the case to be placed in different environment, the revision must be performed in compliance with local standards.

The service inspection is a matter of agreement by and between the client and service organisation.

11 TECHNICAL DATA II

11.1 OPERATION DATA

Type			111 / 111-c	222 / 222-c	404 / 404-c	707 / 707-c	1212 / 1212-c
Operation temperature *)	from 0 °C to	°C	100 (decontamination 160 °C)				xx
	from -20 °C to	°C	100 (decontamination 160 °C)				70
Temperature precision	space at 10 °C at 37 °C	approximately (±)°C	< 0,5	< 0,5	< 1	< 1	<1,5
			< 0,5	< 0,5	< 1	< 1	<1,5
	time	approximately (±)°C	< 0,2	< 0,2	< 0,3	< 0,4	< 0,8
Time of heating	to 37 °C from ambient temperature	min	<11	<11	<22	<13	<30
Time of cooling	from temperature 22 °C to 10 °C	min	< 21 / < 11	<17 / <14	<19 / <21	<21 / <22	<21
Time of restoration after 30 s door opening according to DIN 12880	at 37 °C	min	< 5	< 2	< 10	6	10
	at 50 °C	min	< 6	< 3	< 13	6	10
Relative humidity	range	%	10 - 95				
Precision T _{chamber} ≥ 21 °C	time	approximately (±) % RH	< 2				
Concentration of CO ₂		%	0,1 - 20				xx
Required pressure of CO ₂		bar/psi	0,3 - 0,7 / 5 - 10				xx

All the data apply in empty chamber (without samples on screens) for ambient temperature of 20 - 22 °C, 100 % fan revolutions, feeding voltage 230 V ± 10 %.

*) Option of cooling up to -20 °C, performance with decontamination – temperature 160 °C. If there is used lighting or CO₂ sensor, the allowed temperature is lower.

11.2 RACKS WITH EXPOSITION LIGHTING

FLUORESCENT LAMPS

Name CLIMACELL E		111 / 111-c	222 / 222-c	404 / 404-c	707 / 707-c	1212 / 1212-c
Width x depth x height of rack	mm	539x350x90	539x500x123	539x500x123	939x512x93	539x500x123
Number of fluorescent lamps per 1 rack	pc	5	8	8	12	8
Max. number of racks in a chamber	pc	2 / 2	2 / 2	3 / 4	3 / 4	12 / 12
Input per 1 rack	W	75	120	120	180	120
length x diameter of fluorescent lamp	mm	450 / 26				
Usable VIS source (fluorescent lamp): range // colour temperature		400 - 700 nm // 2700 / 3000 / 4000 / 6000 °K				
Usable UV source (fluorescent lamp): range // maximum		300 - 400 nm // maximum 350 nm				
Exposition parameters VIS						
Tube type / input	W/pc	Luxline Plus - colour temperature 4000°K // 15 W				
Lighting: in the centre of the storage rack below the source, in the distance from light source: 10 cm	klux ±10 %	16,5	18	18	20	18
Exposition parameters UV						
Tube type / input	W/pc	Black light blue BLB // 15 W				
Lighting: in the centre of the storage rack below the source, in the distance from light source: 10 cm	mW/cm ² ±10 %	5				
Coverage according to EN 60529		IP 65				
Number of connectors per 1 rack	pc	2	2	2	4	2
Operation temperature range: rack ON, humidity OFF						
1 rack	°C	0 - 100 /	0 - 100 /	0 - 100 /	0 - 100 /	
2 racks	°C	15 - 100 /	15 - 100 /			
3 racks	°C	xx	xx	8 - 100 /	8 - 100 /	
4 racks	°C	xx	xx	xx	xx	
12 racks	°C	xx	xx	xx	xx	
Operation temperature range : rack ON, humidity ON						
1 rack	°C	10 - 90 /	10 - 90 /	10 - 90 /	10 - 90 /	
2 racks	°C	17 - 90 /	15 - 90 /			
3 racks	°C	xx	xx	15 - 90 /	15 - 90 /	
4 racks	°C	xx	xx	xx	xx	
12 racks	°C	xx	xx	xx	xx	
Controlled relative humidity range: rack ON (applies to temperature range 15 - 50 °C)						
1 rack	% RH	10 - 75 /	10 - 75 /	10 - 85 /	10 - 85 /	
2 racks	% RH	10 - 60 /	10 - 60 /			
3 racks	% RH	xx	xx	10 - 60 /	10 - 60 /	
4 racks	% RH	xx	xx	xx	xx	
12 racks	% RH	xx	xx	xx	xx	
Operation temperature and relative humidity range: rack OFF, humidity ON						
Temperature	°C	10 - 90				
RH	% RH	10 - 95				

All the data apply in empty chamber (without samples on screens) for ambient temperature of 20 - 22 °C, 100 % fan revolutions, feeding voltage 230 V ± 10 %.

Current values of photometric items in the course of the experiment must be measured by an independent measuring gauge.

12 WARRANTY AND SERVICE

The guarantee period is marked on the certificate of warranty.

The warranty refers to manufacturing defects or material defects on condition that:

- the product has been installed and used in accordance with the Instructions for use,
- the cause of the defect was not a insufficient maintenance, unqualified intervention in the device or damage through external impacts.

The warranty does not relate to natural wear of material and to consumer material, such as e.g. door sealing, materials for recording devices, accumulators etc. If a defect occurs, draw claims to a warranty repair directly at the nearest BMT service center. Please mention the device name and type, its serial number and how the defect appears (error message, printer record). Provided the warranty conditions are fulfilled there follows, according to the consideration of the service center, the cost-free repair or replacement of the defective part.

If the prescribed maintenance is complied with, the device life exceeds 10 years. At the same time, this is the period for which the manufacturer bears objective responsibility within the meaning of EU Directive no. 85/374/EEC for any potential damage caused by the device operation. If you decide to continue using the device after the said period expiration, ask the manufacturer or an authorized service for an expertise whether or not the device can still be used regarding its wear and tear, technical condition and service availability.

13 TRANSPORT AND STORAGE

The authorised person will prepare the device for transport. The device must be transported and stored in its original package. If you send the device back to the manufacturer (e.g. for repair or replacement within the scope of a claim), use the original package. Otherwise you become responsible for possible damage during transport and the manufacturer will exact from you some compensation for necessary related repairs. The device may be stored in temperatures from 0 °C up to 40 °C.

14 WAY OF LIQUIDATION

The **package** is made of wood, nails, cardboard, paper and plastics, which can be recycled as like as household waste.

For European Union countries:

A product which is no more in use, is of no use for the user



and has the **■■■■■**, abelling, shall be shut down by the user who shall inform the seller (in the Czech Republic: the manufacturer). The product may not be placed in the communal waste and is subject to a regimen according to WEEE (Waste Electric and Electronic Equipment) EU Directive no. 2002/96/EC as amended.

For countries out of European Union:



The label **■■■■■** is valid in European Union countries only. Ask your authorities or the device seller for detailed information about correct liquidation of electric and electronic devices.



... excellence
in medical and laboratory
engineering

Manufactured in the EU



MMM Medcenter Einrichtungen GmbH
Sommelweisstrasse 6
D-82152 Planegg
Germany

T. +49 89 89 92 26 20
F. +49 89 89 92 26 30
e-mail: medcenter@mmmgroup.com